

SMFLHP Single and Dual DC-DC Converters

19 TO 40 VOLT INPUT – 53 TO 100 WATT

FEATURES

- Radiation tolerant space DC-DC converter
 - Single event effects (SEE) LET performance to 86 MeV cm²/mg
 - Total ionizing dose (TID) guaranteed per MIL-STD-883 method 1019, radiation hardness assurance (RHA)
 - P = 30 krad(Si), L = 50 krad(Si), R = 100 krad(Si)
 - 50 - 300 rad(Si)/sec dose rate (Condition A)
 - 10 mrad(Si)/sec dose rate (Condition D)
- Parallel up to 3 converters—maximum recommended power is 70% of the total available power.
- Operating temperature -55 °C to +125 °C
- Qualified to MIL-PRF-38534 Class H and K
- Input voltage range 19 to 40 volts
- Transient protection up to 80 volts for 50 ms
 - Converter will shut down at an input voltage above approximately 45 volts
- Fully isolated, magnetic feedback
- Fixed high switching frequency
- Remote sense and output trim on single output models
- Primary and secondary inhibit function
- Synchronization input and output
- Indefinite short circuit protection
- High power density with up to 87% typical efficiency



MODELS	
OUTPUT VOLTAGE (V)	
SINGLE	DUAL
3.3	±5
5	±12
12	±15
15	

DESCRIPTION

The Interpoint® SMFLHP Series™ 28 volt DC-DC converters are rated up to 100 watts output power in a radiation tolerant design operating over a -55 °C to +125 °C temperature range with a 28 volt nominal input. The low profile SMFLHP converters are manufactured in our fully certified and qualified MIL-PRF-38534 Class K production facility and packaged in hermetically sealed steel cases. They are ideal for use in programs requiring high reliability, small size, and high levels of radiation hardness assurance. On dual output models, up to 70% of the rated output power can be drawn from either the positive or negative outputs. The welded, hermetically sealed package is only 3.005 x 1.505 x 0.400 inches.

SCREENING

SMFLHP converters offer screening options to space prototype (O), Class H or K and radiation hardness assurance (RHA) levels P - 30 krad(Si), L - 50 krad(Si) or R - 100 krad(Si). Single event effects (SEE) LET performance to 86 MeV cm²/mg. See Table 9 on page 13 and Table 10 on page 14 for more information.

DESIGN FEATURES

The SMFLHP Series converters are switching regulators that use a quasi-square wave, single ended forward converter design with a constant switching frequency of 600 kHz.

Isolation between input and output circuits is provided with a transformer in the forward path and wide bandwidth magnetic coupling in the feedback control loop. The SMFLHP Series uses a unique dual loop feedback technique that controls output current with an inner feedback loop and output voltage with a cascaded voltage mode feedback loop.

The additional secondary current mode feedback loop improves transient response in a manner similar to primary current mode control and allows for ease of paralleling.

Tight load regulation is achieved through a wide-bandwidth magnetic feedback circuit.

INHIBIT

The SMFLHP Series converters have two inhibit terminals (Inhibit 1 and Inhibit 2) that can be used to disable power conversion, resulting in a very low quiescent input current. See Table 5 on page 6 for specifications.

SYNC

Converters may be synced to an external clock (525 to 675 kHz) or to one another by using the sync in or out pins. See Table 5 on page 6 for specifications.

SMFLHP Single and Dual DC-DC Converters

19 TO 40 VOLT INPUT – 53 TO 100 WATT

SENSE AND TRIM

Single output models provide sense to maintain voltage at the load. The converters output voltage can also be trimmed up. See Figure 1.

The units designated as slaves have the Master/Inhibit 2 pin (pin 12) connected to the Sense Return pin (pin 9) of the master unit. Figure 2 on page 3 shows the typical setup for two or three units in parallel.

CURRENT SHARING AND PARALLEL OPERATION

For increased power parallel up to 3 converters. The maximum recommended power is 70% of the total available power. Multiple SMFLHP converters may be used in parallel to drive a common load. Only single output models with Sense and Sense Return can be used in the share mode. In this mode of operation the load current is shared by two or three SMFLHP converters.

A second slave unit may be placed in parallel with a master and slave; this requires the Triple pin (pin 3) of the master unit to be connected to the Sense Return pins (pin 9) Figure 2.

In current sharing mode, one SMFLHP converter is designated as a master. The Slave pin (pin 11) of the master is left unconnected and the Master/Inhibit 2 pin (pin 12) of the master is connected to the Slave pin (pin 11) of the slave units.

In current sharing mode, the converters function as a current source. For this reason it is important that their outputs be connected to the common ground at all times to prevent an excessively high voltage at their outputs.

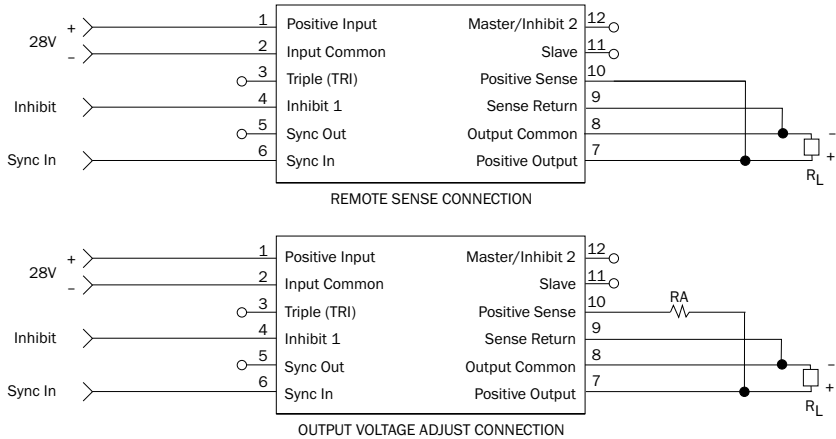

V _{OUT} INCREASE VOLTS	R _A (Ω)			
	3.3 V	5 V	12 V	15 V
0.1	66	77	27	21
0.2	131	153	55	43
0.3	196	230	82	64
0.4	262	307	109	86
0.5	349	396	139	109

- Notes
1. When using remote sense for voltage compensation or when using remote sense for trim, the output will drift over temperature. Contact Applications Engineering for more information powerapps@crane-eg.com.
 2. Do not exceed the maximum rated power.

FIGURE 1: SENSE CONNECTIONS AND TRIM TABLE – SINGLE OUTPUT MODELS

SMFLHP Single and Dual DC-DC Converters

19 TO 40 VOLT INPUT – 53 TO 100 WATT

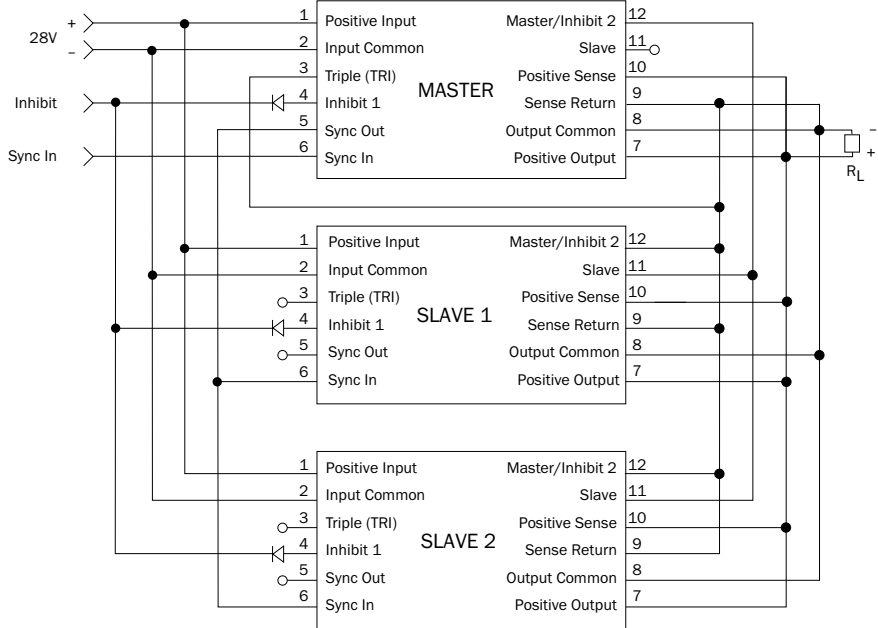

CONNECT TRIPLE (TRI) ONLY WHEN 2 SLAVES ARE USED

Notes

1. No one converter may carry more than its maximum rated current.
2. Individual converter operation, load and layout may affect the actual current shared. Contact Applications Engineering for more information at powerapps@crane-eg.com.
3. When paralleling SMFLHPs, a diode is required at the input of each inhibit pin as SMFLHPs do not have an internal diode on the inhibit pin.

FIGURE 2: PARALLEL CONNECTIONS – SINGLE OUTPUT MODELS

SMFLHP Single and Dual DC-DC Converters

19 TO 40 VOLT INPUT – 53 TO 100 WATT

PIN OUT		
Pin	Single Output	Dual Output
1	Positive Input	Positive Input
2	Input Common	Input Common
3	Triple (TRI)	Triple (TRI)
4	Inhibit 1 (INH1)	Inhibit 1 (INH1)
5	Sync Out	Sync Out
6	Sync In	Sync In
7	Positive Output	Positive Output
8	Output Common	Output Common
9	Sense Return	Negative Output
10	Positive Sense	No connection
11	Slave	Slave
12	Master/Inhibit 2 (MSTR/INH2)	Master/Inhibit 2 (MSTR/INH2)

TABLE 1: PIN OUT

PINS NOT IN USE	
Triple (TRI)	Leave unconnected
Inhibit 1 (INH1)	Leave unconnected
Sync Out	Leave unconnected
Sync In	Connect to Input Common
Sense Return	Connect to appropriate outputs
Positive Sense	Connect to appropriate outputs
Slave	Leave unconnected
Master/Inhibit 2 (MSTR/INH2)	Leave unconnected

TABLE 2: PINS NOT IN USE

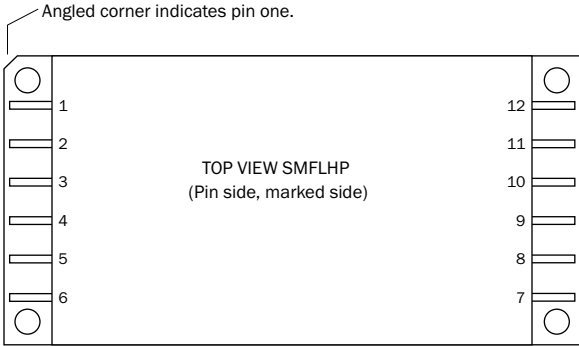

See Figure 17 on page 12 for dimensions.

FIGURE 3: PIN OUT

SMFLHP Single and Dual DC-DC Converters

19 TO 40 VOLT INPUT – 53 TO 100 WATT

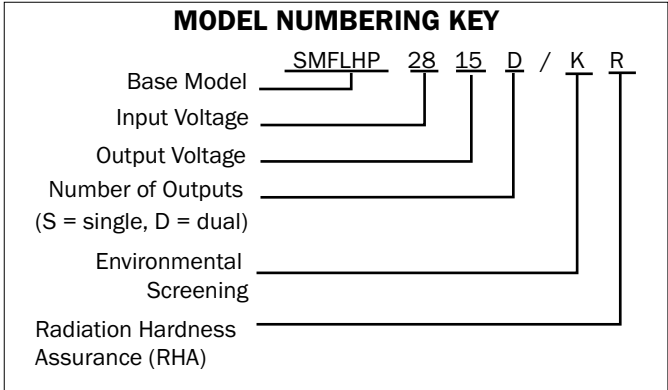

FIGURE 4: MODEL NUMBERING KEY

SMD NUMBERS	
STANDARD MICROCIRCUIT DRAWING (SMD)	SMFL SERIES SIMILAR PART
5962R0620901KXC	SMFLHP283R3S/KR
5962R1221402KXC	SMFLHP2805S/KR
5962R0822301KXC	SMFLHP2815D/KR
<p>The SMD numbers shown are for RHA level R, screening level Class K, standard case (X), standard pin seal and non-solder dipped pins (C). For other options please refer to the SMD for the SMD number and the vendor similar number. All SMD numbers are listed on the SMD in the "Bulletin" which is the last page of the SMD. For exact specifications for an SMD product, refer to the SMD. SMDs can be downloaded from https://landandmaritimeapps.dla.mil/programs/smcr</p>	

TABLE 3: SMD NUMBER CROSS REFERENCE

MODEL NUMBER OPTIONS					
TO DETERMINE THE MODEL NUMBER ENTER ONE OPTION FROM EACH CATEGORY IN THE FORM BELOW.					
CATEGORY	Base Model and Input Voltage	Output Voltage ¹	Number of Outputs ²	Screening ³	RHA ⁴
OPTIONS	SMFLHP28	3R3, 05, 12, 15	S	O	O
		05, 12, 15	D	H	P
				K	L R
FILL IN FOR MODEL # ⁵	SMFLHP28	_____	_____	/ _____	_____
<p>Notes</p> <p>1. Output Voltage: An R indicates a decimal point. 3R3 is 3.3 volts out. The value of 3R3 is only available in single output models.</p> <p>2. Number of Outputs: S is a single output and D is a dual output.</p> <p>3. Screening: A screening level of O is a Space Prototype and is only used with RHA O. See Table 10 on page 14 and Table 9 on page 13 for more information.</p> <p>4. RHA: Interpoint model numbers use an "O" in the RHA designator position to indicate the "-" (dash) RHA level of MIL-PRF-38534, which is defined as "no RHA." RHA O is only available with Screening level O. See Table 9 on page 13 for more information.</p> <p>5. If ordering by model number add a "-Q" to request solder dipped leads (SMFLHP2815D/KR-Q).</p>					

TABLE 4: MODEL NUMBER OPTIONS

SMFLHP Single and Dual DC-DC Converters

19 TO 40 VOLT INPUT – 53 TO 100 WATT

TABLE 5: OPERATING CONDITIONS, ALL MODELS, 25 °C CASE, 28 VIN, 100% LOAD, UNLESS OTHERWISE SPECIFIED.

PARAMETER	CONDITIONS	ALL MODELS			UNITS
		MIN	TYP	MAX	
LEAD SOLDERING TEMPERATURE ¹	10 SECONDS MAX.	–	–	300	°C
STORAGE TEMPERATURE ¹		-65	–	+150	°C
CASE OPERATING TEMPERATURE	FULL POWER	-55	–	+125	°C
	ABSOLUTE ¹	-55	–	+135	
DERATING OUTPUT POWER/CURRENT ¹	LINEARLY	From 100% at 125 °C to 0% at 135 °C			
ESD RATING ^{1, 2} MIL-PRF-38534, 3.9.5.8.2	MIL STD 883 METHOD 3015	>8000			V
	CLASS 3B				
ISOLATION: INPUT TO OUTPUT, INPUT TO CASE, OUTPUT TO CASE ³	@ 500 VDC AT 25 °C	100	–	–	Megohms
INPUT TO OUTPUT CAPACITANCE ¹		–	150	–	pF
CURRENT LIMIT ⁴	% OF FULL LOAD	–	125	–	%
UNDERVOLTAGE LOCKOUT ¹ -55 °C TO +125 °C	RISING VIN (TURN ON)	16.0	–	18.5	V
	FALLING VIN (TURN OFF)	13.4	–	16.7	
AUDIO REJECTION ¹		–	50	–	dB
SWITCHING FREQUENCY	-55 °C TO +125 °C	525	–	675	kHz
SYNCHRONIZATION IN -55 °C TO +125 °C	INPUT FREQUENCY	525	–	675	kHz
	DUTY CYCLE ¹	40	–	60	%
	ACTIVE LOW	–	–	0.8	V
	ACTIVE HIGH ¹	4.5	–	5.0	
	REFERENCED TO	INPUT COMMON			
IF NOT USED	CONNECT TO INPUT COMMON				
SYNCHRONIZATION OUT	REFERENCED TO	INPUT COMMON			
	IF NOT USED	LEAVE UNCONNECTED			
INHIBIT 1 ACTIVE LOW (OUTPUT DISABLED) Do not apply a voltage to the inhibit pin. ⁵	INHIBIT PIN PULLED LOW	–	–	0.8	V
	INHIBIT PIN SOURCE CURRENT ¹	–	–	10	mA
	REFERENCED TO	INPUT COMMON			
INHIBIT 1 ACTIVE HIGH (OUTPUT ENABLED) Do not apply a voltage to the inhibit pin. ⁵	INHIBIT PIN CONDITION	OPEN COLLECTOR OR UNCONNECTED			
	OPEN INHIBIT PIN VOLTAGE ¹	9	–	12	V
INHIBIT 2 ACTIVE LOW (OUTPUT DISABLED) Do not apply a voltage to the inhibit pin. ⁵	INHIBIT PIN PULLED LOW	–	–	0.5	V
	INHIBIT PIN SOURCE CURRENT ¹	–	–	5	mA
	REFERENCED TO	OUTPUT COMMON			
INHIBIT 2 ACTIVE HIGH (OUTPUT ENABLED) Do not apply a voltage to the inhibit pin. ⁵	INHIBIT PIN CONDITION	OPEN COLLECTOR OR UNCONNECTED			
	OPEN INHIBIT PIN VOLTAGE ¹	–	–	9	V

For mean time between failures (MTBF) contact Applications Engineering at powerapps@craneae.com or call +1 425.882.3100.

Notes

1. Guaranteed by characterization test and/or analysis. Not a production test.
2. Passed 8000 volts.
3. Isolation is tested with the all input pins (referenced to input common) tied together, and all output pins (referenced to output common) tied together. They are tested for isolation input to output, input to case and output to case. Discharge the pins after each test.
4. Current limit is defined as the point at which the output voltage decreases by 1%. Dual outputs: The over-current limit will trigger when the sum of the currents from both outputs reaches 125% (typical value) of the maximum rated "total" current of both outputs.
5. An external inhibit interface should be used to pull the inhibits low or leave them floating. The inhibit pins can be left unconnected if not used.

SMFLHP Single and Dual DC-DC Converters

19 TO 40 VOLT INPUT – 53 TO 100 WATT

TABLE 6: ELECTRICAL CHARACTERISTICS -55 °C TO +125 °C CASE, 28 VIN, 100% LOAD, FREE RUN, UNLESS OTHERWISE SPECIFIED.

SINGLE OUTPUT MODELS		SMFLHP283R3S			SMFLHP2805S			UNITS
PARAMETER	CONDITIONS	MIN	TYP	MAX	MIN	TYP	MAX	
OUTPUT VOLTAGE		3.23	3.30	3.37	4.875	5.00	5.125	V
OUTPUT CURRENT	V _{IN} = 19 TO 40 V	0	–	16	0	–	16	A
OUTPUT POWER	V _{IN} = 19 TO 40 V	0	–	53	0	–	80	W
OUTPUT RIPPLE 10 KHZ - 2 MHZ	T _C = 25 °C	–	10	25	–	15	50	mV p-p
	T _C = -55 °C TO +125 °C	–	20	40	–	30	90	
LINE REGULATION	V _{IN} = 19 TO 40 V	–	0	50	–	0	50	mV
LOAD REGULATION	NO LOAD TO FULL	–	0	20	–	0	20	mV
INPUT VOLTAGE	CONTINUOUS	19	28	40	19	28	40	V
NO LOAD TO FULL	TRANSIENT 50 ms ^{1, 2}	–	–	80	–	–	80	
INPUT CURRENT	NO LOAD	–	70	120	–	90	175	mA
	INHIBITED - INH1	–	9	15	–	9	15	
	INHIBITED - INH2	–	35	80	–	35	80	
INPUT RIPPLE CURRENT	10 KHZ - 10 MHZ	–	30	80	–	30	80	mA p-p
EFFICIENCY ³	T _C = 25 °C	70	72	–	76	80	–	%
	T _C = -55 °C TO +125 °C	65	–	–	74	–	–	
LOAD FAULT ⁴	POWER DISSIPATION	–	15	24	–	15	22	W
SHORT CIRCUIT	RECOVERY ¹	–	1.5	10	–	1.5	10	ms
STEP LOAD RESPONSE ^{4, 5} 50% - 100% - 50%	TRANSIENT	–	±350	±400	–	±350	±450	mV pk
	RECOVERY ¹	–	1.5	3.0	–	1.5	3.0	ms
STEP LINE RESPONSE ^{1, 4, 6} 19 - 40 - 19 V	TRANSIENT	–	±250	±400	–	±250	±400	mV pk
	RECOVERY ¹	–	200	300	–	200	600	µs
START-UP ^{4, 7}	DELAY	–	3.5	10	–	3.5	10	ms
	OVERSHOOT ¹	–	0	25	–	0	25	mV pk
CAPACITIVE LOAD ^{1, 8}	T _C = 25 °C	–	–	1000	–	–	1000	µF

Notes

1. Guaranteed by characterization test and/or analysis. Not a production test.
2. Converter will shut down above approximately 45 +V but will be undamaged and will restart when voltage drops into normal range.
3. "OO" product may be 2% lower.
4. Recovery time is measured from application of the transient to point at which V_{out} is within 1% of final value.
5. Step load test is performed at 10 microseconds typical.
6. Step line test is performed at 100 microseconds ± 20 microseconds.
7. Tested on release from inhibit.
8. No affect on dc performance.

SMFLHP Single and Dual DC-DC Converters

19 TO 40 VOLT INPUT – 53 TO 100 WATT

TABLE 7: ELECTRICAL CHARACTERISTICS -55°C TO +125°C CASE, 28 VIN, 100% LOAD, FREE RUN, UNLESS OTHERWISE SPECIFIED.

SINGLE OUTPUT MODELS		SMFLHP2812S			SMFLHP2815S			UNITS
PARAMETER	CONDITIONS	MIN	TYP	MAX	MIN	TYP	MAX	
OUTPUT VOLTAGE		11.76	12.00	12.24	14.55	15.00	15.45	V
OUTPUT CURRENT	V _{IN} = 19 TO 40 V	0	–	7.5	0	–	6.67	A
OUTPUT POWER	V _{IN} = 19 TO 40 V	0	–	90	0	–	100	W
OUTPUT RIPPLE 10 KHZ - 2 MHZ	T _C = 25°C	–	30	85	–	30	95	mV p-p
	T _C = -55°C TO +125°C	–	45	150	–	45	175	
LINE REGULATION	V _{IN} = 19 TO 40 V	–	0	50	–	0	50	mV
LOAD REGULATION	NO LOAD TO FULL	–	0	20	–	0	20	mV
INPUT VOLTAGE NO LOAD TO FULL	CONTINUOUS	19	28	40	19	28	40	V
	TRANSIENT 50 ms ^{1, 2}	–	–	80	–	–	80	
INPUT CURRENT	NO LOAD	–	80	80	–	80	120	mA
	INHIBITED - INH1	–	9	15	–	9	15	
	INHIBITED - INH2	–	35	80	–	35	80	
INPUT RIPPLE CURRENT	10 KHZ - 10 MHZ	–	30	80	–	30	80	mA p-p
EFFICIENCY ³	T _C = 25°C	81	86	–	82	87	–	%
	T _C = -55°C TO +125°C	79	–	–	80	–	–	
LOAD FAULT ⁴	POWER DISSIPATION	–	15	22	–	15	30	W
SHORT CIRCUIT	RECOVERY ¹	–	1.5	10	–	1.5	10	ms
STEP LOAD RESPONSE ^{4, 5} 50% - 100% - 50%	TRANSIENT	–	±450	±700	–	±450	±700	mV pk
	RECOVERY ¹	–	1.5	3.0	–	1.5	3.0	ms
STEP LINE RESPONSE ^{1, 4, 6} 19 - 40 - 19 V	TRANSIENT	–	±250	±800	–	±250	±800	mV pk
	RECOVERY	–	200	600	–	200	600	µs
START-UP ^{4, 7}	DELAY	–	3.5	10	–	3.5	10	ms
	OVERSHOOT ¹	–	0	50	–	0	50	mV pk
CAPACITIVE LOAD ^{1, 8}	T _C = 25°C	–	–	1000	–	–	1000	µF

Notes

1. Guaranteed by characterization test and/or analysis. Not a production test.
2. Converter will shut down above approximately 45 volts input but will be undamaged and will restart when voltage drops into normal range.
3. "OO" product may be 2% lower.
4. Recovery time is measured from application of the transient to point at which V_{out} is within 1% of final value.
5. Step load test is performed at 10 microseconds typical.
6. Step line test is performed at 100 microseconds ± 20 microseconds.
7. Tested on release from inhibit.
8. No affect on dc performance.

SMFLHP Single and Dual DC-DC Converters

19 TO 40 VOLT INPUT – 53 TO 100 WATT

TABLE 8: ELECTRICAL CHARACTERISTICS -55°C TO +125°C CASE, 28 VIN, 100% LOAD, FREE RUN, UNLESS OTHERWISE SPECIFIED.

DUAL OUTPUT MODELS		SMFLHP2805D			SMFLHP2812D			SMFLHP2815D			UNITS
PARAMETER	CONDITIONS	MIN	TYP	MAX	MIN	TYP	MAX	MIN	TYP	MAX	
OUTPUT VOLTAGE	+ V _{OUT}	4.85	5.00	5.15	11.64	12.00	12.36	14.55	15.00	15.45	V
	- V _{OUT}	4.82	5.00	5.18	11.58	12.00	12.42	14.47	15.00	15.53	
OUTPUT CURRENT ² V _{IN} = 19 TO 40 V	EITHER OUTPUT	0	±8	11.2	0	±3.75	5.3	0	±3.33	4.67	A
	TOTAL	–	–	16.0	0	–	7.5	0	–	6.67	
OUTPUT POWER ² V _{IN} = 19 TO 40 V	EITHER OUTPUT	0	±40	56	0	±45	63	0	±50	70	W
	TOTAL	0	–	80	0	–	90	0	–	100	
OUTPUT RIPPLE 10 KHZ - 2 MHZ, ±V _{OUT}	T _C = 25°C	–	25	100	–	50	125	–	50	120	mV p-p
	T _C = -55°C TO +125°C	–	–	150	–	–	175	–	–	225	
LINE REGULATION V _{IN} = 19 TO 40 V	+ V _{OUT}	–	0	50	–	0	50	–	0	50	mV
	- V _{OUT}	–	25	100	–	25	100	–	25	100	
LOAD REGULATION NO LOAD TO FULL	+ V _{OUT}	–	0	50	–	10	100	–	10	100	mV
	- V _{OUT}	–	25	100	–	50	200	–	50	200	
CROSS REGULATION T _C = 25°C	SEE NOTE 3	–	–	400	–	–	480	–	–	600	mV
	SEE NOTE 4	–	–	400	–	–	480	–	–	600	
INPUT VOLTAGE NO LOAD TO FULL	CONTINUOUS	19	28	40	19	28	40	19	28	40	V
	TRANSIENT 50 ms ^{1, 5}	0	–	80	0	–	80	0	–	80	
INPUT CURRENT	NO LOAD	–	50	80	–	50	120	–	50	120	mA
	INHIBITED - INH1	–	9	14	–	9	14	–	9	14	
	INHIBITED - INH2	–	35	80	–	35	80	–	35	80	
INPUT RIPPLE CURRENT	10 KHZ - 10 MHZ	–	30	80	–	30	80	–	30	80	mA p-p
EFFICIENCY BALANCED LOAD	T _C = 25°C	75	80	–	83	86	–	82	87	–	%
	T _C = -55°C TO +125°C	73	–	–	81	–	–	80	–	–	
LOAD FAULT ⁶ SHORT CIRCUIT	POWER DISSIPATION	–	15	25	–	15	22	–	15	21	W
	RECOVERY ¹	–	1.5	10	–	1.5	4.0	–	1.5	4.0	
STEP LOAD RESPONSE ^{6, 7} ± V _{OUT} , 50% - 100% - 50%	TRANSIENT	–	±350	±450	–	±450	±700	–	±450	±700	mV pk
	RECOVERY ¹	–	1.5	3.0	–	1.5	3.0	–	1.5	3.0	
STEP LINE RESPONSE ^{1, 6, 8} ± V _{OUT} , 19 - 40 - 19 V	TRANSIENT	–	±250	±600	–	±250	±800	–	±250	±800	mV pk
	RECOVERY	–	200	300	–	200	600	–	200	600	
START-UP ^{6, 9}	DELAY	–	3.5	20	–	3.5	20	–	3.5	20	ms
	OVERSHOOT ¹	–	0	25	–	0	50	–	0	50	
CAPACITIVE LOAD ^{1, 10, 11}	T _C = 25°C	–	–	500	–	–	500	–	–	500	µF

Notes

1. Guaranteed by characterization test and/or analysis. Not a production test.
2. Up to 70% of the total output power/current is available from either output provided the opposite output is carrying 30% of the power/current in use.
3. Effect on negative V_{out} from 50%/50% loads to 30%/70% or 70%/30% loads.
4. Effect on negative V_{out} from 50%/50% loads to 10% then 50% load on negative V_{out}
5. Converter will shut down above approximately 45 volts but will be undamaged and will restart when voltage drops into normal range.
6. Recovery time is measured from application of the transient to point at which V_{out} is within 1% of final value.
7. Step load test is performed at 10 microseconds typical.
8. Step line test is performed at 100 microseconds ± 20 microseconds.
9. Tested on release from inhibit.
10. No affect on dc performance.
11. Applies to each output.

SMFLHP Single and Dual DC-DC Converters

19 TO 40 VOLT INPUT - 53 TO 100 WATT

TYPICAL PERFORMANCE PLOTS: 25 °C CASE, 28 VIN, 100% LOAD, FREE RUN, UNLESS OTHERWISE SPECIFIED.
These are examples for reference only and are not guaranteed specifications.

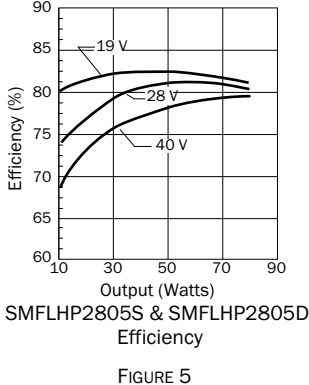

FIGURE 5

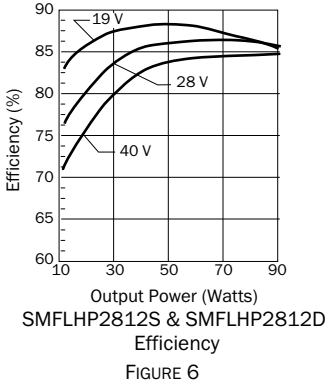

FIGURE 6

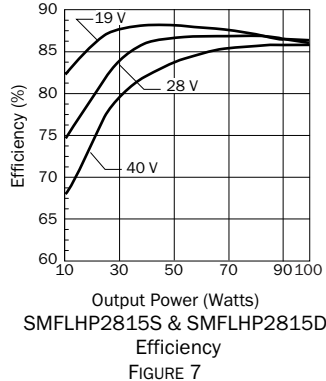

FIGURE 7

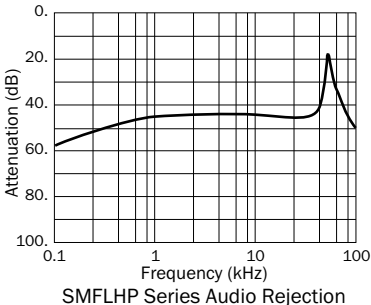

FIGURE 8

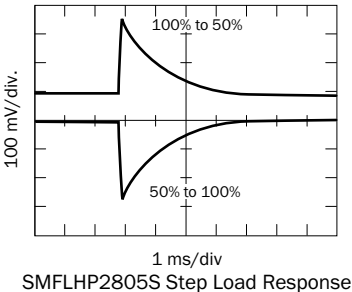

FIGURE 9

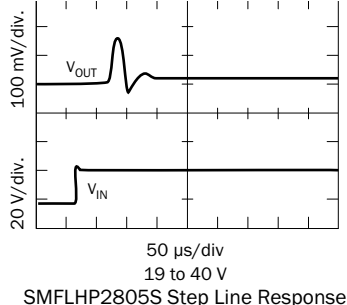

FIGURE 10

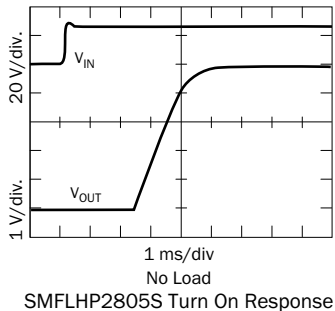

FIGURE 11

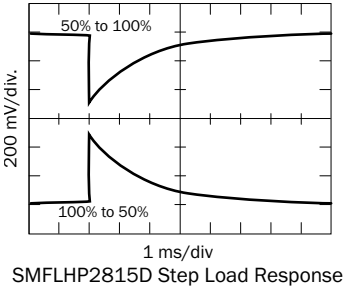

FIGURE 12

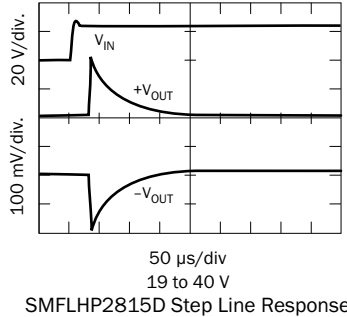
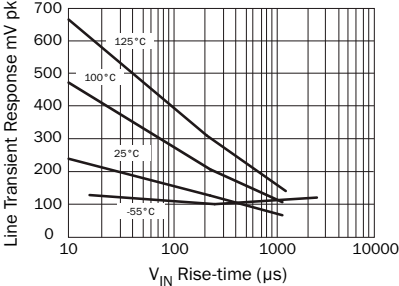

FIGURE 13

SMFLHP Single and Dual DC-DC Converters

19 TO 40 VOLT INPUT – 53 TO 100 WATT

TYPICAL PERFORMANCE PLOTS: 25 °C CASE, 28 VIN, 100% LOAD, FREE RUN, UNLESS OTHERWISE SPECIFIED.
These are examples for reference only and are not guaranteed specifications.



SMFLHP2815D Line Transient Response vs. V_{IN} Rise-time

FIGURE 14

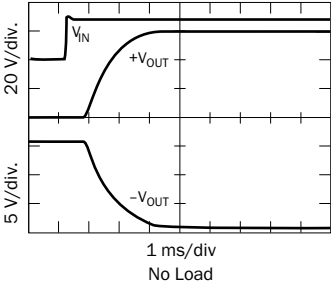

SMFLHP2815D Turn On Response

FIGURE 15

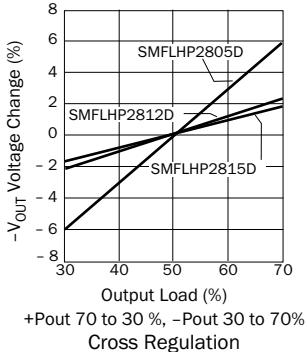

FIGURE 16

SMFLHP Single and Dual DC-DC Converters

19 TO 40 VOLT INPUT – 53 TO 100 WATT

TOP VIEW CASE U Flanged case, short leads

Case "U" does not require an option in the Case Option position of the model number.

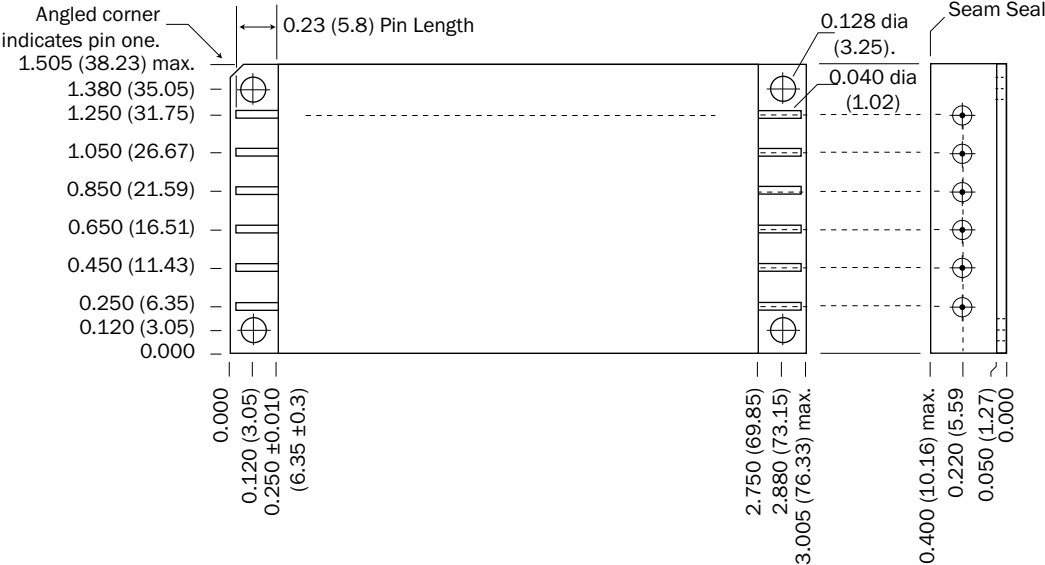

Weight: 86 grams maximum

Case dimensions in inches (mm)
Tolerance ± 0.005 (0.13) for three decimal places
 ± 0.01 (0.3) for two decimal places
unless otherwise specified

CAUTION
Heat from reflow or wave soldering may damage the device. Solder pins individually with heat application not exceeding 300 °C for 10 seconds per pin.

Materials
Header Cold Rolled Steel/Nickel/Gold
Cover Kovar/Nickel
Pins #52 alloy/Gold, compression glass seal
Gold plating of 50 - 150 microinches is included in pin diameter
Seal Hole: 0.120 ± 0.002 (3.05 ± 0.05)

Please refer to the numerical dimensions for accuracy.

FIGURE 17: CASE U

SMFLHP Single and Dual DC-DC Converters

19 TO 40 VOLT INPUT – 53 TO 100 WATT

ELEMENT EVALUATION TABLES FOR QML PRODUCTS ARE IN “APP-009 QUALITY AND CERTIFICATION”, APPENDIX A, IN COMPLIANCE WITH MIL-PRF-38534 REVISION L.
(LINK [HTTPS://WWW.CRANEE.COM/QUALITY-ASSURANCE-MODULAR-POWER](https://www.cranee.com/quality-assurance-modular-power))

ENVIRONMENTAL SCREENING SPACE DC-DC CONVERTERS PROTOTYPE, CLASS H AND K

TEST PERFORMED	NON-QML ¹	QML ^{2, 3}	
	PROTOTYPE (/O) ⁴	CLASS H (/H)	CLASS K (/K)
Non-destruct wire bond pull, Method 2023		■ ⁵	■
Pre-cap Inspection, Method 2017, 2032	■	■	■
Temperature Cycle (10 times) Method 1010, Cond. C, -65 °C to +150 °C, ambient	■	■	■
Constant Acceleration Method 2001, 3000 g	■	■	■
PIND, Test Method 2020, Cond. A		■ ⁵	■
Pre burn-in test, Group A, Subgroups 1 and 4	■	■ ⁵	■
Burn-in Method 1015, +125 °C case, typical ⁶ 96 hours	■		
160 hours		■	
2 x 160 hours (includes mid-BI test)			■
Final Electrical Test, MIL-PRF-38534, Group A, Subgroups 1 and 4: +25 °C case	■		
Subgroups 1 through 6, -55 °C, +25 °C, +125 °C case		■	■
Hermeticity Test, Method 1014 Gross Leak, Cond. B ₂ , Kr85			■
Gross Leak, Cond. C ₁ , fluorocarbon	■	■	
Fine Leak, Cond. B ₁ , Kr85			■
Fine Leak, Cond. A ₂ , helium	■	■	
Radiography, Method 2012			■
Post Radiography Electrical Test, +25 °C case			■ ⁵
Final visual inspection Method 2009 of MIL-STD-883 Magnification 1X ⁷	■	■	■

Test methods are referenced to MIL-STD-883 as determined by MIL-PRF-38534.

Notes

1. Non-QML prototype products may not meet all of the requirements of MIL-PRF-38534.
2. All processes are QML qualified and performed by certified operators.
3. Class H or K QML products that have no SMD number are marked “CHP, CHL, CHR, CKP, CKL or CKR” per MIL-PRF-38534, Table III instead of “QML”.
4. “O” in the RHA designator position in Interpoint model numbers indicates DLA RHA “-” defined as no RHA.
5. Not required by DLA but performed to assure product quality.
6. Burn-in temperature designed to bring the case temperature to +125 °C minimum. Burn-in is a powered test.
7. Visual inspection is performed per an internal document. Product may contain cosmetic irregularities such as dents, dings, scratches, etc. that do not affect form, fit or function.

TABLE 9: ENVIRONMENTAL SCREENING SPACE DC-DC CONVERTERS PROTOTYPE, CLASS H AND K

SMFLHP Single and Dual DC-DC Converters

19 TO 40 VOLT INPUT – 53 TO 100 WATT

SPACE RADIATION HARDNESS ASSURANCE DC-DC CONVERTERS CLASS H AND K, RHA¹ P, L AND R

QUALIFICATION PER MIL-STD	QML ²					
	CLASS H			CLASS K		
	/HP	/HL	/HR	/KP	/KL	/KR
RHA P: 30 krad(Si) total dose ^{3, 4}	■			■		
RHA L: 50 krad(Si) total dose ^{3, 4}		■			■	
RHA R: 100 krad(Si) total dose ^{3, 4}			■			■
SEE, LET 86 MeV cm ² /mg ⁵	■	■	■	■	■	■

Test methods are referenced to MIL-STD-883 as determined by MIL-PRF-38534.

- Notes
1. DLA has approved the RHA plan for Interpoint power products. Our SMD products with RHA “P”, “L” or “R” code meet DLA requirements.
 2. Class H or K QML products that have no SMD number are marked “CHP, CHL, CHR, CKP, CKL or CKR” per MIL-PRF-38534, Table III instead of “QML”.
 3. Radiation sensitive components internal to the devices are procured with radiation guarantees or undergo radiation lot acceptance testing (RLAT) performed per condition A, method 1019 of MIL-STD-883.
 4. Representative devices were initially High Dose Rate (HDR) tested using condition A of method 1019 of MIL-STD 883 to ensure RHA designator levels. Representative devices have also been Low Dose Rate (LDR) tested using condition D of method 1019 of MIL-STD-883 to the RHA designator levels. Representative devices will also be re-tested after design or process changes that can affect RHA response of this device.
 5. Single event testing was performed on a converter to 86 MeV-cm²/mg using 15 MeV/nucleon gold ions with no latch-up, burn-out, functional interrupts, or gate ruptures exhibited. Single event upsets (output voltage transients) may be present up to 86 MeV-cm²/mg.

TABLE 10: SPACE RADIATION HARDNESS ASSURANCE DC-DC CONVERTERS CLASS H AND K, RHA P, L AND R

