

# SLH Single and Dual DC-DC Converters

## 16 TO 40 VOLT INPUT – 1.5 WATT

### FEATURES

- Radiation tolerant space DC-DC converter  
Single event effects (SEE) LET performance to 86 MeV cm<sup>2</sup>/mg  
Total ionizing dose (TID) guaranteed per MIL-STD-883 method 1019, radiation hardness assurance (RHA)  
L = 50 krad(Si), R = 100 krad(Si)
- Operating temperature -55 °C to +125 °C
- Qualified to MIL-PRF-38534 Class H and K
- Input voltage range 16 to 40 V
- Transient protection 50 V for 50 ms
- Fully isolated magnetic feedback
- Inhibit function
- Indefinite short circuit protection
- Soft-start function limits inrush current during startup



MODELS	
OUTPUT VOLTAGE (V)	
SINGLES	DUALS
5	±5
12	±12
15	±15

### DESCRIPTION

The Interpoint® SLH Series™ of DC-DC converters offers up to 1.5 watts of power in a radiation tolerant design. The low profile SLH converters are manufactured in our fully certified and qualified MIL-PRF-38534 Class K production facility and packaged in hermetically sealed steel cases. They are ideal for use in programs requiring high reliability, small size, and high levels of radiation hardness assurance. A small footprint of 0.79 square inches saves board space. The wide input voltage range of 16 to 40 volts accepts the varying voltages of space, military, or aerospace bus power and regulates output voltages to protect downstream components. Single output models feature outputs of 5, 12, or 15 volts, and dual output models feature outputs of ±5, ±12 and ±15 volts.

### SCREENING

SLH converters offer screening to Class H or K and radiation hardness assurance (RHA) levels L - 50 krad(Si) or R - 100 krad(Si). Single event effects (SEE) LET performance to 86 MeV cm<sup>2</sup>/mg. See Table 9 on page 12 for more information. The SLH2805D is available

### CONVERTER DESIGN

SLH Series DC-DC converters incorporate a flyback topology with a variable switching frequency. Feedback provides output voltage regulation. Output voltage is magnetically fed back to the input side of the PWM to regulate output voltage.

Up to 80% of the load of the dual output models may be on one output providing that the other output carries a minimum of 20% of the total load. The dual models can be used as a single output voltage by connecting the load between positive and negative outputs, leaving the common unconnected resulting in double the output voltage. (for example, SLH2805D can be used as a 10 volt output.)

When used with an Interpoint STF28-461 filter, the combination will meet the requirements of MIL-STD-461C, CE03.

### INHIBIT FUNCTION

The SLH Series incorporates an inhibit terminal that can be used to disable internal switching. The converter is inhibited when an active low (≤ 0.5 V) signal is applied to the inhibit pin (pin 7). In the inhibit mode the inhibit pin sources up to 2 mA maximum. The converter resumes normal operation when an open circuit is applied to the inhibit pin. The open circuit voltage of the inhibit is 7 to 8 volts. Do not apply an external pull-up to the inhibit terminal.

### PROTECTION FEATURES

All models include a soft-start function to prevent large current draw and minimize overshoot. The converters provide short circuit protection (by restricting the current) and output overload protection.

### CONVENIENT PACKAGING

The SLH Series converters are packaged in hermetically sealed metal cases which provide EMI/RFI shielding.

# SLH Single and Dual DC-DC Converters

**16 TO 40 VOLT INPUT – 1.5 WATT**

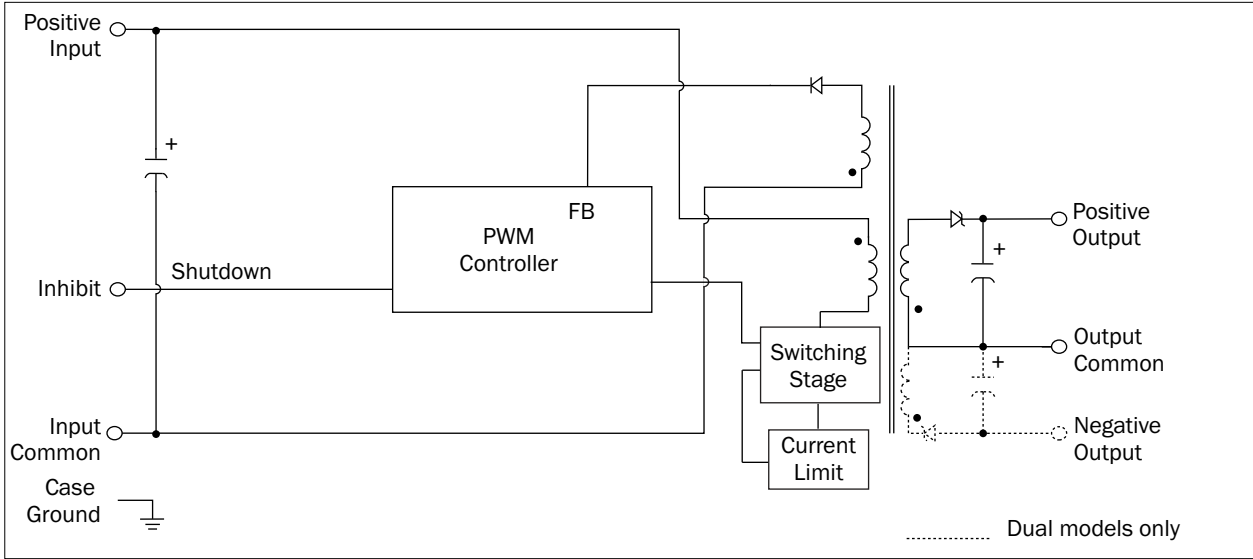
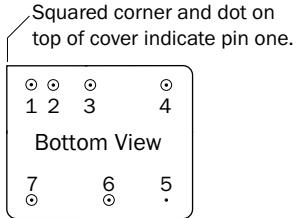

FIGURE 1: SLH BLOCK DIAGRAM

PIN OUT		
Pin	Single Output	Dual Output
1	Positive Input	Positive Input
2	Input Common	Input Common
3	Positive Output	Positive Output
4	Output Common	Output Common
5	Case Ground	Case Ground
6	No Connection	Negative Output
7	Inhibit	Inhibit

TABLE 1: PIN OUT



See Figure 23 on page 10 for dimensions.

FIGURE 2: PIN OUT

PINS NOT IN USE	
Inhibit	Leave unconnected
“No Connection” pin	Leave unconnected

TABLE 2: PINS NOT IN USE

# SLH Single and Dual DC-DC Converters

## 16 TO 40 VOLT INPUT – 1.5 WATT

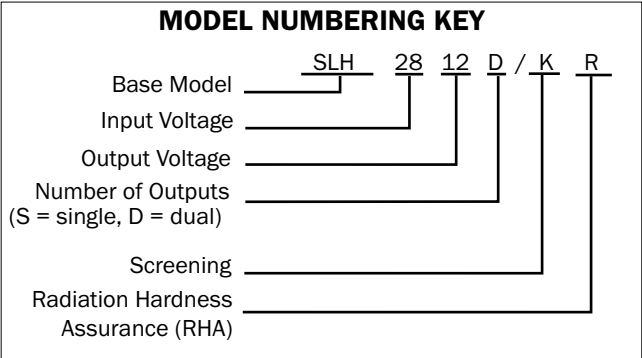

FIGURE 3: MODEL NUMBERING KEY

SMD NUMBERS	
STANDARD MICROCIRCUIT DRAWING (SMD)	SLH SIMILAR PART
5962R0052601KXC	SLH2805S/KR
5962R0052701KXC	SLH2812S/KR
5962R0052801KXC	SLH2815S/KR
5962R0250402KXC	SLH2805D/KR
5962R9955602KXC	SLH2812D/KR
5962R9852902KXC	SLH2815D/KR

SMD numbers shown are for screening level Class H, standard case (X), standard pin seal and non-solder dipped pins (C). For other options please refer to the SMD for the SMD number and the vendor similar number. All SMD numbers are listed on the SMD in the "Bulletin" which is the last page of the SMD. For exact specifications for an SMD product, refer to the SMD. SMDs can be downloaded from <https://landandmaritimeapps.dla.mil/programs/smcr>

TABLE 3: SMD NUMBER CROSS REFERENCE

MODEL NUMBER OPTIONS					
ON THE LINES BELOW, ENTER ONE SELECTION FROM EACH CATEGORY TO DETERMINE THE MODEL NUMBER.					
CATEGORY	Base Model and Input Voltage	Output Voltage	Number of Outputs <sup>1</sup>	Screening <sup>2</sup>	RHA <sup>3</sup>
OPTIONS	SLH28	05, 12, 15	S	O	O
		05, 12, 15	D	H	P <sup>4</sup>
				K	L
					R
FILL IN FOR MODEL # <sup>5</sup>	<u>SLH28</u>	_____	_____	/ _____	_____

Notes:  
 1. Number of Outputs: S is a single output and D is a dual output.  
 2. Screening: A screening level of O is a Space Prototype and is only used with RHA O. See Table 8 on page 11 and Table 9 on page 12 for more information.  
 3. RHA: Interpoint model numbers use an "O" in the RHA designator position to indicate the "-" (dash) RHA level of MIL-PRF-38534, which is defined as "no RHA." RHA O is only available with Screening level O. See Table 9 on page 12 for more information.  
 4. RHA P is only available for SLH2805D.  
 5. If ordering by model number add a "Q" to request solder dipped leads (SLH2805S/KR-Q).

TABLE 4: MODEL NUMBER OPTIONS

# SLH Single and Dual DC-DC Converters

## 16 TO 40 VOLT INPUT – 1.5 WATT

TABLE 5: OPERATING CONDITIONS - ALL MODELS, 25 °C CASE, 28 VOLTS VIN, UNLESS OTHERWISE SPECIFIED

PARAMETER	CONDITIONS	ALL MODELS			UNITS
		MIN	TYP	MAX	
LEAD SOLDERING TEMPERATURE <sup>1</sup>	10 SECONDS MAX.	–	–	300	°C
STORAGE TEMPERATURE		-65	–	+150	°C
CASE OPERATING TEMPERATURE	FULL POWER	-55	–	+125	°C
	ABSOLUTE <sup>1</sup>	-55	–	+135	
DERATING OUTPUT POWER/CURRENT <sup>1</sup>	LINEARLY	From 100% at 125 °C to 0% at 135 °C			
ESD RATING <sup>1, 2</sup> MIL-PRF-38534, 3.9.5.8.2	MIL-STD-883 METHOD 3015 CLASS 3B	–	–	≥8000	v
ISOLATION: INPUT TO OUTPUT, INPUT TO CASE, OUTPUT TO CASE <sup>3</sup>	@ 500 VDC AT 25 °C	100	–	–	Megohms
INPUT TO OUTPUT CAPACITANCE <sup>1</sup>		–	100 - 170	–	pF
SWITCHING FREQUENCY <sup>4</sup> -55 ° TO +125 °C	5, 12, 15, ±5 AND ±15 ±12	220 220	280 –	320 420	kHz
INHIBIT ACTIVE LOW (OUTPUT DISABLED) Do not apply a voltage to the inhibit pin <sup>5</sup>	INHIBIT PIN PULLED LOW	–	–	0.5	v
	INHIBIT PIN SOURCE CURRENT <sup>1</sup>	–	–	2	mA
	REFERENCED TO	INPUT COMMON			
INHIBIT ACTIVE HIGH (OUTPUT ENABLED) Do not apply a voltage to the inhibit pin <sup>5</sup>	INHIBIT PIN CONDITION	OPEN COLLECTOR OR UNCONNECTED			
	OPEN INHIBIT PIN VOLTAGE <sup>1</sup>	7	–	8	v

For mean time between failures (MTBF) contact Applications Engineering at [powerapps@craneae.com](mailto:powerapps@craneae.com)

#### Notes

1. Guaranteed by characterization test and/or analysis. Not a production test.
2. Passes 8000 volts.
3. When testing isolation, input pins are tied together and output pins are tied together. They are tested against each other and against case. Discharge the pins before and after testing.
4. Since the SLH is a variable frequency converter, the frequency range, with different line and load conditions, can be significantly different than the stated values in this table.
5. An external inhibit interface should be used to pull the inhibit low or leave it floating. The inhibit pin can be left unconnected if not used. Do not apply an external pull-up.

# SLH Single and Dual DC-DC Converters

## 16 TO 40 VOLT INPUT – 1.5 WATT

TABLE 6: ELECTRICAL CHARACTERISTICS: -55° TO +125° C CASE, 28 VIN, 100% LOAD, UNLESS OTHERWISE SPECIFIED

SINGLE OUTPUT MODELS		SLH2805S			SLH2812S			SLH2815S			UNITS
PARAMETER	CONDITIONS	MIN	TYP	MAX	MIN	TYP	MAX	MIN	TYP	MAX	
OUTPUT VOLTAGE <sup>2</sup>		4.80	5.00	5.20	11.52	12.00	12.48	14.40	15.00	15.60	V
OUTPUT CURRENT	V <sub>IN</sub> = 16 TO 40 V	–	–	300	–	–	125	–	–	100	mA
OUTPUT POWER	V <sub>IN</sub> = 16 TO 40 V	–	–	1.5	–	–	1.5	–	–	1.5	W
OUTPUT RIPPLE 10 kHz - 2 MHz	T <sub>C</sub> = 25°C	–	65	150	–	35	200	–	60	200	mV p-p
	T <sub>C</sub> = -55°C TO +125°C	–	–	250	–	–	300	–	–	300	
LINE REGULATION	V <sub>IN</sub> = 16 TO 40 V	–	115	300	–	60	400	–	60	650	mV
LOAD REGULATION <sup>3</sup>	LOAD 10% TO 100%	–	440	700	–	380	700	–	410	700	mV
INPUT VOLTAGE	CONTINUOUS NO LOAD TO FULL	16	28	40	16	28	40	16	28	40	V
	TRANSIENT <sup>1</sup> 50 ms	–	–	50	–	–	50	–	–	50	
INPUT CURRENT	NO LOAD	–	2.9	17	–	2.3	17	–	2.4	17	mA
	INHIBITED	–	1.3	5	–	1.3	5	–	1.3	5	
INPUT RIPPLE CURRENT <sup>4</sup>	10 kHz - 10 MHz	–	85	250	–	75	300	–	60	300	mA p-p
EFFICIENCY	T <sub>C</sub> = 25°C	72	79	–	80	87	–	80	88	–	%
	T <sub>C</sub> = -55°C TO +125°C	69	–	–	69	–	–	69	–	–	
LOAD FAULT <sup>5, 6</sup>	SHORT CIRCUIT POWER DISSIPATION	–	0.4	1.5	–	0.3	1.2	–	0.3	1.2	W
	RECOVERY <sup>1</sup>	–	–	30	–	–	30	–	–	30	ms
STEP LOAD RESPONSE <sup>6, 7</sup> 50% - 100% - 50%	TRANSIENT	–	±250	±400	–	±220	±700	–	±220	±700	mV pk
	RECOVERY <sup>1</sup>	–	–	400	–	–	400	–	–	400	µs
STEP LINE RESPONSE <sup>1, 6, 8</sup> 16 - 40 - 16 V	TRANSIENT	–	–	±600	–	–	±600	–	–	±600	mV pk
	RECOVERY	–	–	500	–	–	500	–	–	500	µs
START-UP <sup>6, 9</sup>	DELAY	–	1	20	–	1	20	–	1	20	ms
	OVERSHOOT <sup>1</sup>	–	–	100	–	–	500	–	–	500	mV pk
CAPACITIVE LOAD <sup>1</sup> T <sub>C</sub> = 25°C	NO EFFECT ON DC PERFORMANCE	–	–	100	–	–	100	–	–	100	µF

## Notes:

1. Guaranteed by characterization test and/or analysis. Not a production test.
2. Specified at 50% load.
3. Although no minimum load is required, at no load the output voltage may exceed rating by up to approximately 15%.
4. An external 6 µH inductor, added in series to the input, is necessary to maintain specifications.

5. Load fault is a short circuit into 1 ohm. Recovery is into resistive full load.
6. Recovery and start-up times are measured from application of the transient or change in condition to the point at which V<sub>OUT</sub> is within 1% of final value.
7. Step load test is performed at 10 microseconds typical. Step load response is mostly due to the effects of load regulation. See Figure 10 on page 8.
8. Step line test is performed at 100 microseconds ± 20 microseconds.
9. Measured from release of inhibit.

# SLH Single and Dual DC-DC Converters

## 16 TO 40 VOLT INPUT – 1.5 WATT

TABLE 7: ELECTRICAL CHARACTERISTICS: -55° TO +125° C CASE, 28 VIN, 100% LOAD, UNLESS OTHERWISE SPECIFIED

DUAL OUTPUT MODELS		SLH2805D			SLH2812D			SLH2815D			UNITS
PARAMETER	CONDITIONS	MIN	TYP	MAX	MIN	TYP	MAX	MIN	TYP	MAX	
OUTPUT VOLTAGE <sup>2</sup>	$\pm V_{OUT}$	4.80	5.00	5.20	11.52	12.00	12.48	14.40	15.00	15.60	V
OUTPUT CURRENT <sup>3</sup> $V_{IN} = 16$ TO 40 V	EACH OUTPUT	–	150	240	–	62.5	100	–	50	80	mA
	TOTAL			300			125			100	
OUTPUT POWER <sup>3</sup> $V_{IN} = 16$ TO 40 V	EACH OUTPUT	–	0.75	1.2	–	0.75	1.2	–	0.75	1.2	W
	TOTAL			1.5			1.5			1.5	
OUTPUT RIPPLE 10 kHz - 2 MHz $\pm V_{OUT}$	$T_C = 25^\circ C$	–	–	150	–	–	200	–	–	300	mV p-p
	$T_C = -55^\circ C$ TO $+125^\circ C$	–	–	250	–	–	400	–	–	500	
LINE REGULATION $\pm V_{OUT}$	$V_{IN} = 16$ TO 40 V	–	75	400	–	75	700	–	85	650	mV
LOAD REGULATION <sup>4</sup> 10% - 100%	BALANCED LOADS	–	310	700	–	350	700	–	370	700	mV
	$\pm V_{OUT}$										
INPUT VOLTAGE	CONTINUOUS NO LOAD TO FULL	16	28	40	16	28	40	16	28	40	V
	TRANSIENT <sup>1</sup> 50 ms	0	–	50	0	–	50	0	–	50	
INPUT CURRENT	NO LOAD	–	3.1	17	–	3.1	17	–	3.3	17	mA
	INHIBITED	–	1.4	5	–	1.4	5	–	1.4	5	
INPUT RIPPLE CURRENT <sup>5</sup>	10 kHz - 10 MHz	–	80	250	–	90	300	–	100	300	mA p-p
EFFICIENCY	$T_C = 25^\circ C$	72	75	–	80	87	–	80	87	–	%
	$T_C = -55^\circ C$ TO $+125^\circ C$	69	–	–	69	–	–	69	–	–	
LOAD FAULT <sup>6, 7</sup>	SHORT CIRCUIT POWER DISSIPATION	–	0.3	1.5	–	0.3	1.2	–	0.3	1.2	W
	RECOVERY <sup>1</sup>	–	–	30	–	1	30	–	1	30	ms
STEP LOAD RESPONSE <sup>7, 8</sup> BALANCED LOADS 50% - 100% - 50% $\pm V_{OUT}$	TRANSIENT	–	$\pm 150$	$\pm 400$	–	$\pm 170$	$\pm 600$	–	$\pm 200$	$\pm 700$	mV pk
	RECOVERY <sup>1</sup>	–	–	600	–	–	360	–	–	600	$\mu s$
STEP LINE RESPONSE <sup>1, 7, 9</sup> 16 - 40 - 16 V, $\pm V_{OUT}$	TRANSIENT	–	–	$\pm 600$	–	–	$\pm 600$	–	–	$\pm 600$	mV pk
	RECOVERY	–	–	500	–	–	500	–	–	500	$\mu s$
START-UP <sup>7, 10</sup> $\pm V_{OUT}$	DELAY	–	1	20	–	2	20	–	2	20	ms
	OVERSHOOT <sup>1</sup>	–	–	500	–	–	500	–	–	500	mV pk
CAPACITIVE LOAD <sup>1</sup> $T_C = 25^\circ C$ , EACH OUTPUT	NO EFFECT ON DC PERFORMANCE	–	–	50	–	–	50	–	–	50	$\mu F$

## Notes

- Guaranteed by characterization test and/or analysis. Not a production test.
- Specified at 50%/50% balanced loads and one half of full load.
- Maximum specification indicates 80% of the converter's total current/power is available from either output, provided the other output carries 20% of the total power.
- Although no minimum load is required, at no load the output voltage may exceed rating by up to approximately 15%.
- An external 6  $\mu H$  inductor, added in series to the input, is necessary to maintain specifications.
- Load fault is a short circuit into 1 ohm. Recovery is into resistive full load.
- Recovery and start-up times are measured from application of the transient or change in condition to the point at which  $V_{OUT}$  is within 1% of final value.
- Step load test is performed at 10 microseconds typical. Step load response is mostly due to the effects of load regulation. See Figure 18 on page 9.
- Step line test is performed at 100 microseconds  $\pm$  20 microseconds.
- Measured from release of inhibit.

# SLH Single and Dual DC-DC Converters

## 16 TO 40 VOLT INPUT – 1.5 WATT

Typical Performance Plots: 28 Vin, 25 °C Case, 100% load, unless otherwise specified.  
These are examples for reference only and are not guaranteed specifications.

EMI: Representative of all SLH Models

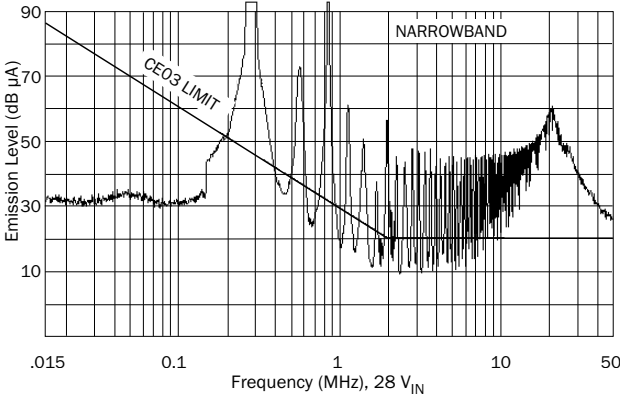

SLH Unfiltered  
FIGURE 4

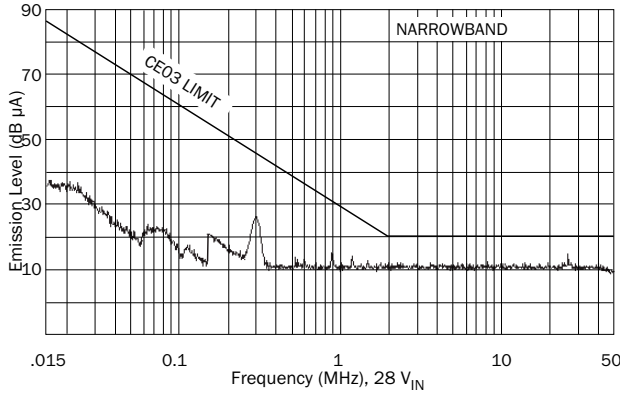

SLH2805S with STF EMI Filter and required 4 μF capacitors (per STF datasheet), MIL-STD-461C, CE03  
FIGURE 5

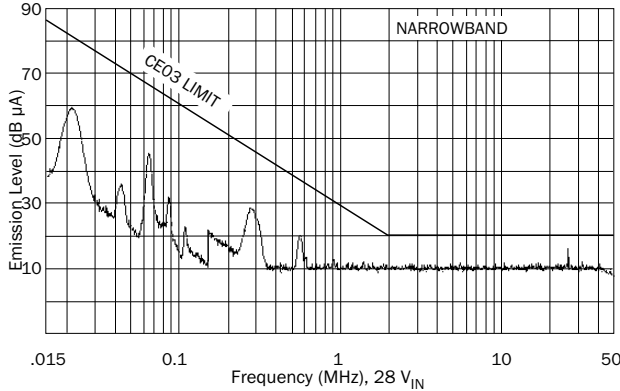

Two SLH2805S with STF EMI Filter and required 4 μF capacitors (per STF datasheet), MIL-STD-461C, CE03  
FIGURE 6

# SLH Single and Dual DC-DC Converters

## 16 TO 40 VOLT INPUT – 1.5 WATT

Typical Performance Plots: 28 Vin, 25 °C Case, 100% load, unless otherwise specified.  
These are examples for reference only and are not guaranteed specifications.

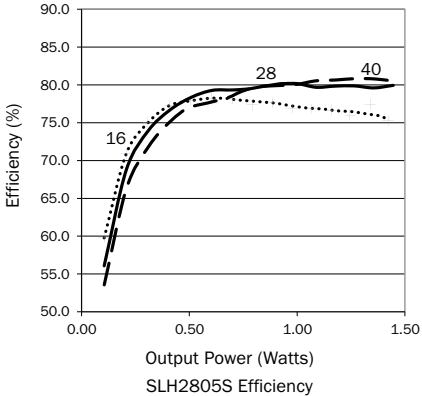

FIGURE 7

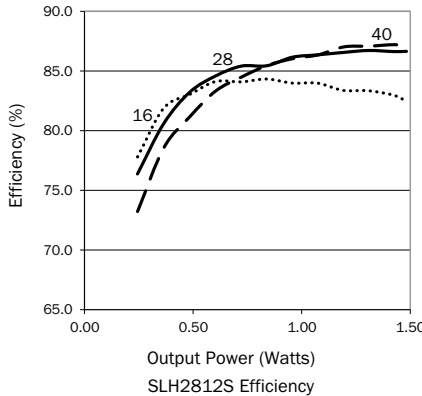

FIGURE 8

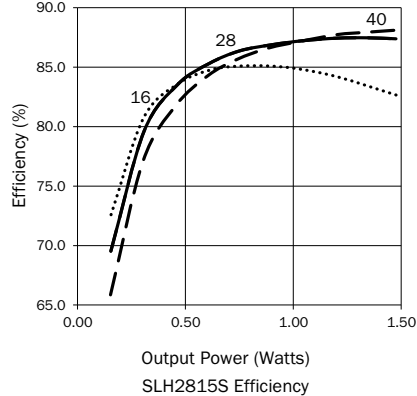
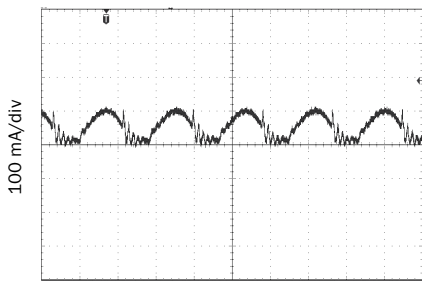

FIGURE 9



6 μH inductor in series with input

Representative of Single Input Ripple Current

FIGURE 10

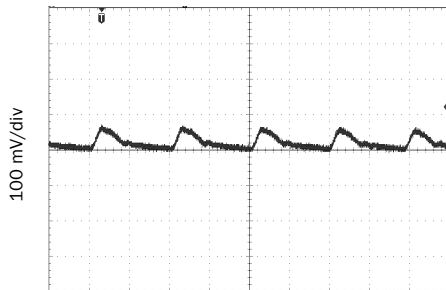

Representative of Single Output Ripple Voltage

FIGURE 11

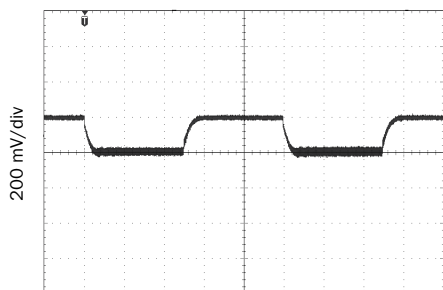

Representative of Single Output Load Transient

FIGURE 12

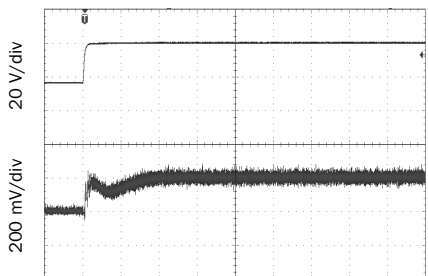

Vin 16 to 40 to 16 Volts, full resistive load

Representative of Single Output Line Transient

FIGURE 13

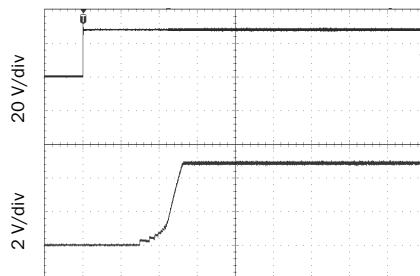

Representative of Single Output Turn-On Delay

FIGURE 14



# SLH Single and Dual DC-DC Converters

## 16 TO 40 VOLT INPUT – 1.5 WATT

Typical Performance Plots: 28 Vin, 25 °C Case, 100% load, unless otherwise specified.  
These are examples for reference only and are not guaranteed specifications.

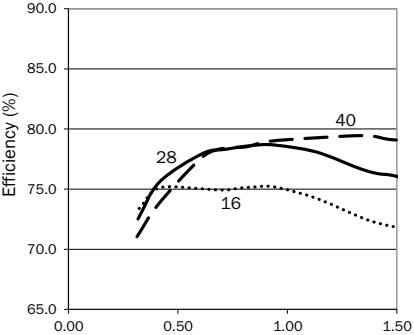

Output Power (Watts)  
SLH2805D Efficiency

FIGURE 15

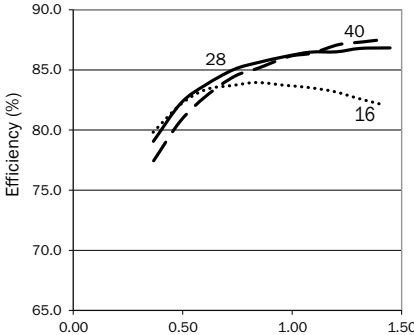

Output Power (Watts)  
SLH2812D Efficiency

FIGURE 16

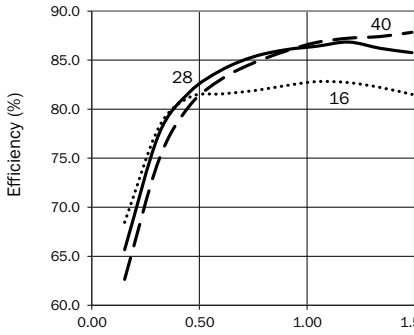

Output Power (Watts)  
SLH2815D Efficiency

FIGURE 17

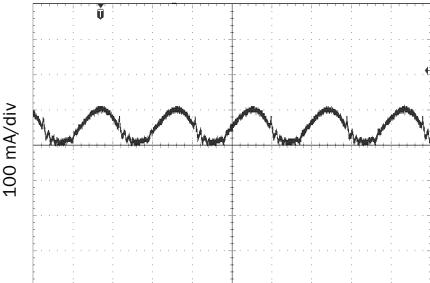

2 µs/div  
6 µH inductor in series with input

Representative of Dual Input Ripple Current

FIGURE 18

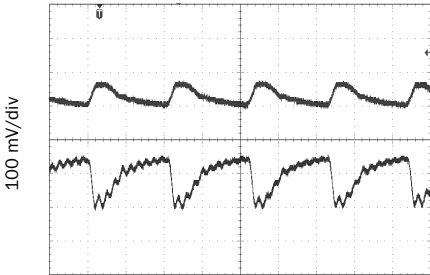

2 µs/div

Representative of Dual Output Ripple Voltage

FIGURE 19

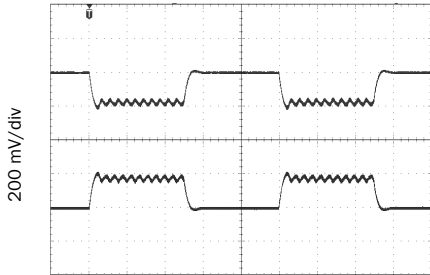

400 µs/div

Representative of Dual Output Load Transient

FIGURE 20

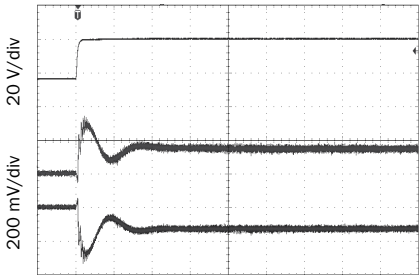

100 µs/div  
Vin 16 to 40 to 16 Volts, full resistive load  
Representative of Dual Output Line Transient

FIGURE 21

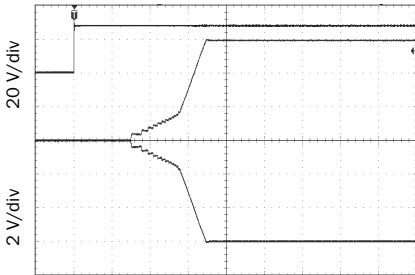

Representative of Dual Output Turn-On Delay

FIGURE 22

# SLH Single and Dual DC-DC Converters

## 16 TO 40 VOLT INPUT - 1.5 WATT

### BOTTOM VIEW CASE A2

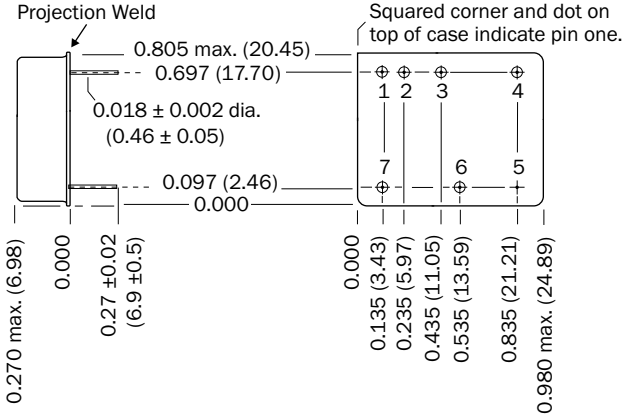

Weight: 12 grams typical

Case dimensions in inches (mm)  
Tolerance ±0.005 (0.13) for three decimal places  
±0.01 (0.3) for two decimal places  
unless otherwise specified

**CAUTION**  
Solder pins individually with heat application not exceeding 300 °C for 10 seconds per pin.

**Materials**  
Header Kovar/Nickel/Gold  
Cover Kovar/Nickel  
Pins Kovar/Nickel/Gold matched glass seal  
Gold plating of 50 - 225 microinches included in pin diameter  
Seal hole: 0.056 ± 0.001 (1.42 ± 0.03)

Please refer to the numerical dimensions for accuracy.

FIGURE 23: CASE A2

# SLH Single and Dual DC-DC Converters

## 16 TO 40 VOLT INPUT – 1.5 WATT

ELEMENT EVALUATION TABLES FOR QML PRODUCTS ARE IN “APP-009 QUALITY AND CERTIFICATION”, APPENDIX A, IN COMPLIANCE WITH MIL-PRF-38534 REVISION L.  
( LINK [HTTPS://WWW.CRANEAE.COM/QUALITY-ASSURANCE-MODULAR-POWER](https://www.craneae.com/quality-assurance-modular-power) )

## ENVIRONMENTAL SCREENING SPACE DC-DC CONVERTERS PROTOTYPE, CLASS H AND K

TEST PERFORMED	NON-QML <sup>1</sup>	QML <sup>2, 3</sup>	
	PROTOTYPE (/O) <sup>4</sup>	CLASS H (/H)	CLASS K (/K)
<b>Non-destruct wire bond pull, Method 2023</b>		■ <sup>5</sup>	■
<b>Pre-cap Inspection, Method 2017, 2032</b>	■	■	■
<b>Temperature Cycle (10 times)</b> Method 1010, Cond. C, -65 °C to +150 °C, ambient	■	■	■
<b>Constant Acceleration</b> Method 2001, 3000 g	■	■	■
<b>PIND, Test Method 2020, Cond. A</b>		■ <sup>5</sup>	■
<b>Pre burn-in test, Group A, Subgroups 1 and 4</b>	■	■ <sup>5</sup>	■
<b>Burn-in Method 1015, +125 °C case, typical <sup>6</sup></b>			
96 hours	■		
160 hours		■	
2 x 160 hours (includes mid-BI test)			■
<b>Final Electrical Test, MIL-PRF-38534, Group A,</b>			
Subgroups 1 and 4: +25 °C case	■		
Subgroups 1 through 6, -55 °C, +25 °C, +125 °C case		■	■
<b>Hermeticity Test, Method 1014</b>			
Gross Leak, Cond. B <sub>2</sub> , Kr85			■
Gross Leak, Cond. C <sub>1</sub> , fluorocarbon	■	■	
Fine Leak, Cond. B <sub>1</sub> , Kr85			■
Fine Leak, Cond. A <sub>2</sub> , helium	■	■	
<b>Radiography, Method 2012</b>			■
<b>Post Radiography Electrical Test, +25 °C case</b>			■ <sup>5</sup>
<b>Final visual inspection</b>			
Method 2009 of MIL-STD-883		■	■
Magnification 1X <sup>7</sup>	■		

Test methods are referenced to MIL-STD-883 as determined by MIL-PRF-38534.

### Notes

1. Non-QML prototype products may not meet all of the requirements of MIL-PRF-38534.
2. All processes are QML qualified and performed by certified operators.
3. Class H or K QML products that have no SMD number are marked “CHP, CHL, CHR, CKP, CKL or CKR” per MIL-PRF-38534, Table III instead of “QML”.
4. “O” in the RHA designator position in Interpoint model numbers indicates DLA RHA “-” defined as no RHA.
5. Not required by DLA but performed to assure product quality.
6. Burn-in temperature designed to bring the case temperature to +125 °C minimum. Burn-in is a powered test.
7. Visual inspection is performed per an internal document. Product may contain cosmetic irregularities such as dents, dings, scratches, etc. that do not affect form, fit or function.

TABLE 8: ENVIRONMENTAL SCREENING DC-DC CONVERTERS PROTOTYPE, CLASS H AND K

# SLH Single and Dual DC-DC Converters

**16 TO 40 VOLT INPUT – 1.5 WATT**

## SPACE RADIATION HARDNESS ASSURANCE SCREENING DC-DC CONVERTERS CLASS H AND K, RHA <sup>1</sup> P, L AND R

QUALIFICATION PER MIL-STD	QML					
	CLASS H			CLASS K		
	/HP	/HL	/HR	/KP	/KL	/KR
<b>RHA P: 30 krad(Si) total dose <sup>2, 3, 4</sup></b>	■			■		
<b>RHA L: 50 krad(Si) total dose <sup>2, 3</sup></b>		■			■	
<b>RHA R: 100 krad(Si) total dose <sup>2, 3</sup></b>			■			■
<b>SEE, LET 86 MeV cm<sup>2</sup>/mg <sup>5</sup></b>	■	■	■	■	■	■

Test methods are referenced to MIL-STD-883 as determined by MIL-PRF-38534.

- Notes
1. DLA has approved the RHA plan for Interpoint power products. Our SMD products with RHA "P", "L" or "R" code meet DLA requirements.
  2. Radiation sensitive components internal to the devices are procured with radiation guarantees or undergo radiation lot acceptance testing (RLAT) performed per condition A, method 1019 of MIL-STD-883.
  3. A representative converter was high dose rate (HDR) tested using condition A of method 1019 of MIL-STD-883 to 150 krad(Si) to ensure RHA designator level "R" (100 krad(Si)).
  4. RHA "P" 30 krad(Si) is only available for SLH2805D.
  5. Single event testing was performed on a converter to 86 MeV-cm<sup>2</sup>/mg using 15 MeV/ nucleon gold ions with no latch-up, burn-out, functional interrupts, or gate ruptures exhibited. Single event upsets (output voltage transients) may be present up to 86 MeV-cm<sup>2</sup>/mg.

TABLE 9: SPACE RADIATION HARDNESS ASSURANCE DC-DC CONVERTERS CLASS H AND K, RHA P, L AND R

