

SMTR Single and Dual DC-DC Converters

28 VOLT INPUT – 30 WATT

FEATURES

- Radiation tolerant space dc-dc converter
 - Single event effects (SEE) LET performance to 86 MeV cm²/mg
 - Total ionizing dose (TID) guaranteed per MIL-STD-883 method 1019, radiation hardness assurance (RHA) P = 30 krad(Si), L = 50 krad(Si), R = 100 krad(Si)
 - 50 - 300 rad(Si)/sec dose rate (Condition A)
 - 10 mrad(Si)/sec dose rate (Condition D)
- Operating temperature -55° to +125°C
- Qualified to MIL-PRF-38534 Class H and K
- Input voltage range 16 to 40 volts
- Transient protection 50 volts for 50 ms
- Fully isolated, magnetic feedback
- Fixed high frequency switching, 600 kHz typical
- Trim function or remote sense on single output models
- Inhibit and synchronization functions
- Indefinite short circuit protection
- Typical efficiency up to 83%



MODELS	
OUTPUT VOLTAGE (V)	
SINGLE	DUAL
3.3	±5
5	±12
12	±15
15	

DESCRIPTION

The Interpoint® SMTR Series™ of 28 volt dc-dc converters offers up to 30 watts of output power from single or dual configurations. They operate over the full military temperature range of -55°C to +125°C with up to 84% efficiency. SMTR converters are packaged in hermetically sealed metal enclosures, making them ideal for use in military, aerospace and other high reliability applications.

SCREENING

SMTR converters offer screening options to space prototype (O), Class H or K and radiation hardness assurance (RHA) levels P - 30 krad(Si), L - 50 krad(Si) or R - 100 krad(Si). Single event effects (SEE) LET performance to 86 MeV cm²/mg. See Table 9 on page 13 and Table 10 on page 14 for more information.

CONVERTER DESIGN

The SMTR converters are constant frequency, pulse-width modulated switching regulators which use a quasi-square wave, single ended, forward converter design. Tight load regulation is maintained by using a wide bandwidth magnetic feedback and, on single output models, through use of remote sense. On dual output models, the positive output is independently regulated and the negative output is cross regulated through the use of tightly-coupled magnetics.

SMTR converters have an internal input filter that helps reduce the need for external components in normal operation. Use our SFMC EMI input filter to meet the requirements of MIL-STD-

461C's CE03. For the lowest noise performance, connection of the case to input common is recommended. The connection can be hard-wired or ac coupled with a small ceramic bypass capacitor. Indefinite short circuit protection and overload protection are provided by a constant current-limit feature. This protective system senses current in the converter's secondary stage and limits it to approximately 140% of the maximum rated output current.

SYNCHRONIZATION

Synchronizing the converter with the system clock allows the designer to confine switching noise to clock transitions, minimizing interference and reducing the need for filtering. In sync mode, the converter will run at any frequency between 500 kHz and 675 kHz. The sync control operates with an active high at any duty cycle between 40% and 60%. The sync pin should be connected to input common pin when not in use.

WIDE VOLTAGE RANGE

SMTR converters are designed to provide full power operation over the input voltage range of 16 to 40 volts. Operation below 16 volts, including MIL-STD-704D emergency power conditions is possible with derated power. Refer to the low line dropout graph, Figure 22 on page 10, for details.

SMTR Single and Dual DC-DC Converters

28 VOLT INPUT – 30 WATT

IMPROVED DYNAMIC RESPONSE

The SMTR Series feed-forward compensation system provides excellent dynamic response and noise rejection. Audio rejection is typically 40 dB. The min. to max. step line transient response is typically less than 4%.

INHIBIT FUNCTION

SMTR converters provide an inhibit terminal that can be used to disable internal switching, resulting in no output voltage and very low quiescent input current. The converter is inhibited when the inhibit pin is pulled below 0.8 V and enabled when its inhibit pin is left floating. An external inhibit interface should be capable of pulling the converter's inhibit pin below 0.8 V while sinking the maximum inhibit current and also allowing the inhibit pin to float high to enable the converter. A voltage should not be applied to the inhibit pin. The open circuit voltage present on the inhibit pin is 9 to 11 V.

TRIM AND REMOTE SENSE (AVAILABLE ON SINGLE OUTPUT MODELS ONLY)

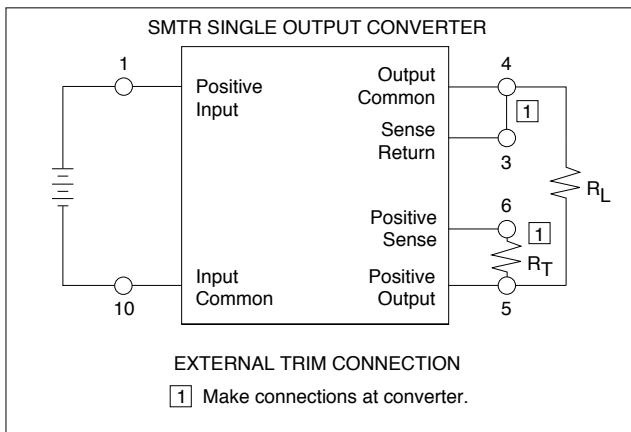

FIGURE 1: TRIM CONNECTION 1, 2, 3, 4

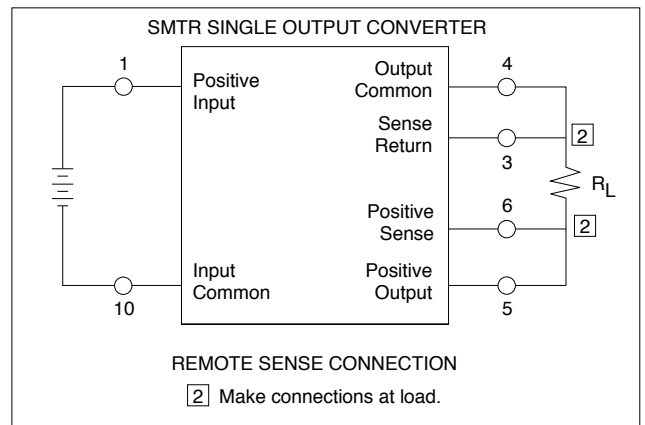

FIGURE 2: REMOTE SENSE 2, 3, 4

Trim Formulas V_{out} = desired output voltage;
 R_T = trim resistor

$$3.3 \text{ V: } R_T = \frac{1300 * V_{out} - 4304}{1.2475}$$

$$5 \text{ V: } R_T = \frac{1300 * V_{out} - 6512}{1.2475}$$

$$12 \text{ V: } R_T = \frac{1300 * V_{out} - 15631}{1.2475}$$

$$15 \text{ V: } R_T = \frac{1300 * V_{out} - 19498}{1.2475}$$

Notes for Remote Sense and Trim

1. When trimming output voltage and/or remote sensing, the total output voltage increase must be less than 0.6 volts at the converters pins. Do not exceed maximum power.
2. If neither voltage trim nor remote sense will be used, connect pin 3 to pin 4 and pin 5 to pin 6 or the output voltage will increase by 1.2 volts.
3. CAUTION: The converter will be permanently damaged if the positive remote sense (pin 6) is shorted to ground. Damage may also result if the output common or positive output is disconnected from the load with the remote sense leads connected to the load.
4. When using remote sense for voltage compensation or when using remote sense for trim, the output will drift over temperature. Contact Applications Engineering for more information at powerapps@crane-eg.com

SMTR Single and Dual DC-DC Converters

28 VOLT INPUT – 30 WATT

PIN OUT		
Pin	Single Output	Dual Output
1	Positive Input	Positive Input
2	Inhibit	Inhibit
3	Sense Return	Positive Output
4	Output Common	Output Common
5	Positive Output	Negative Output
6	Positive Sense	Case Ground
7	Case Ground	Case Ground
8	Case Ground	Case Ground
9	Sync	Sync
10	Input Common	Input Common

TABLE 1: PIN OUT

PINS NOT IN USE	
Inhibit	Leave unconnected
Sync In	Connect to Input Common
Sense Lines	Must be connected to appropriate outputs

TABLE 2: PINS NOT IN USE

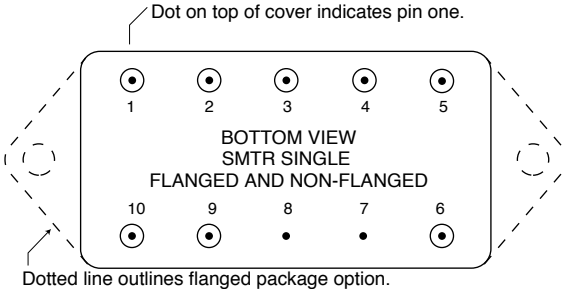

For dimensions see Figure 23 on page 11 and Figure 24 on page 12.

FIGURE 3: PIN OUT SMTR SINGLE OUTPUT MODELS

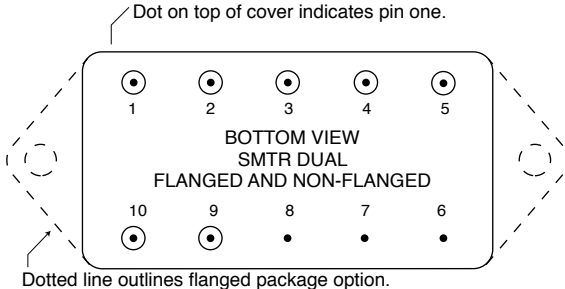

For dimensions see Figure 23 on page 11 and Figure 24 on page 12.

FIGURE 4: PIN OUT SMTR DUAL OUTPUT MODELS

SMTR Single and Dual DC-DC Converters

28 VOLT INPUT – 30 WATT

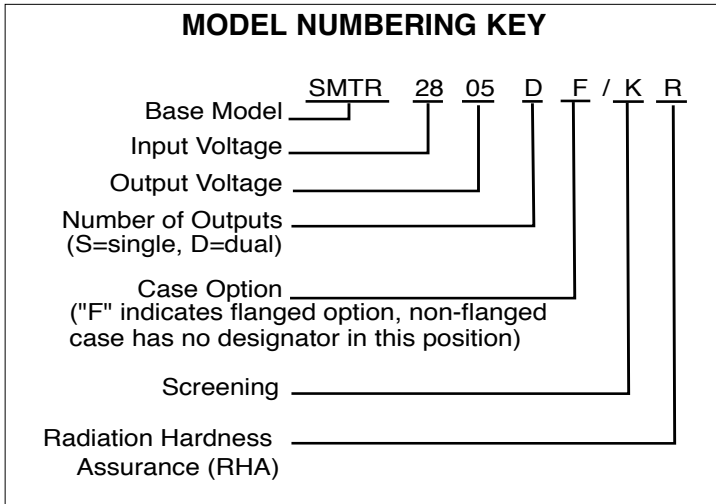

FIGURE 5: MODEL NUMBERING KEY

SMD NUMBERS	
STANDARD MICROCIRCUIT DRAWING (SMD)	SMTR SIMILAR PART
5962R0150102KXC	SMTR283R3S/KR
5962R9306802KXC	SMTR2805S/KR
5962R9306902KXC	SMTR2812S/KR
5962R9307002KXC	SMTR2815S/KR
5962R9320502KXC	SMTR2805D/KR
5962R9307102KXC	SMTR2812D/KR
5962R9307202KXC	SMTR2815D/KR

To indicate the flanged case option change the "X" to "Z" in the SMD number. The SMD number shown is for Class K screening, non-flanged, and radiation hardness assurance (RHA) level R. See the SMD for the numbers for other screening and radiation levels. For exact specifications for an SMD product, refer to the SMD drawing. SMDs can be downloaded from: <http://www.landandmaritime.dla.mil/programs/smcr/>

TABLE 3: SMD NUMBERS

MODEL NUMBER OPTIONS						
TO DETERMINE THE MODEL NUMBER ENTER ONE OPTION FROM EACH CATEGORY IN THE FORM BELOW.						
CATEGORY	Base Model and Input Voltage	Output Voltage ¹	Number of Outputs ²	Case Options ³	Screening ⁴	RHA ⁵
OPTIONS	SMTR	3R3, 05, 12, 15	S	(non-flanged, leave blank)	O	O
		05, 12, 15	D	F (flanged)	H K	P L R
FILL IN FOR MODEL #	SMTR				/	

Notes

- Output Voltage: An R indicates a decimal point. 3R3 is 3.3 volts out. The 3R3 is only available in single output models.
- Number of Outputs: S is a single output and D is a dual output
- Case Options: For the standard case (Figure 23 on page 11) leave the case option blank. For the flanged case option (Figure 24 on page 12), insert the letter F in the Case Option position.
- Screening: A screening level of O is a Space Prototype and is only available with RHA O. See Table 9 on page 13 and Table 10 on page 14 for more information.
- RHA: Interpoint model numbers use an "O" in the RHA designator position to indicate the "-" (dash) RHA level of MIL-PRF-38534, which is defined as "no RHA." RHA O is only available with Screening level O. See Table 10 on page 14 for more information.

TABLE 4: MODEL NUMBER OPTIONS

SMTR Single and Dual DC-DC Converters

28 VOLT INPUT – 30 WATT

TABLE 5: OPERATING CONDITIONS, ALL MODELS, 25°C CASE, 28 VIN, 100% LOAD, UNLESS OTHERWISE SPECIFIED.

PARAMETER	CONDITIONS	ALL MODELS			UNITS
		MIN	TYP	MAX	
LEAD SOLDERING TEMPERATURE ¹	10 SECONDS MAX.	—	—	300	°C
STORAGE TEMPERATURE ¹		-65	—	+150	°C
CASE OPERATING TEMPERATURE	FULL POWER	-55	—	+125	°C
	ABSOLUTE ¹	-55	—	+135	
DERATING OUTPUT POWER/CURRENT ¹	LINEARLY	From 100% at 125°C to 0% at 135°C			
ESD RATING ¹ MIL-PRF-38534, 3.9.5.8.2	MIL-STD-883 METHOD 3015 CLASS 2	2000 - 3999			V
ISOLATION: INPUT TO OUTPUT OR ANY PIN TO CASE EXCEPT CASE PIN	@ 500 VDC AT 25°C	100	—	—	Megohms
INPUT TO OUTPUT CAPACITANCE ¹		—	50	—	pF
CURRENT LIMIT ^{1, 2}	% OF FULL LOAD	—	140	—	%
AUDIO REJECTION ¹		—	40	—	dB
CONVERSION FREQUENCY	FREE RUN -55° TO +125°C	550	600	650	kHz
SYNCHRONIZATION Sync is floating and isolated	INPUT FREQUENCY	500	—	675	kHz
	DUTY CYCLE ¹	40	—	60	%
	ACTIVE LOW	—	—	0.8	V
	ACTIVE HIGH ¹	4.5	—	5	
	REFERENCED TO	INPUT COMMON			
IF NOT USED	CONNECT TO INPUT COMMON				
INHIBIT ACTIVE LOW (OUTPUT DISABLED) Do not apply a voltage to the inhibit pin. ³	INHIBIT PIN PULLED LOW	—	—	0.8	V
	INHIBIT PIN SOURCE CURRENT ¹	—	—	8	mA
	REFERENCED TO	INPUT COMMON			
INHIBIT ACTIVE HIGH (OUTPUT ENABLED) Do not apply a voltage to the inhibit pin. ³	INHIBIT PIN CONDITION	OPEN COLLECTOR OR UNCONNECTED			
	OPEN PIN VOLTAGE ¹	9	—	11	V

**For mean time between failures (MTBF) contact Applications Engineering
powerapps@craneae.com**

Notes

1. Guaranteed by characterization test and/or analysis. Not a production test.
2. Dual outputs: The over-current limit will trigger when the sum of the currents from both outputs reaches 140% (typical value) of the maximum rated "total" current of both outputs.
3. An external inhibit interface should be used to pull the inhibit low or leave it floating. The inhibit pin can be left unconnected if not used.

SMTR Single and Dual DC-DC Converters

28 VOLT INPUT – 30 WATT

TABLE 6: ELECTRICAL CHARACTERISTICS: -55°C TO +125°C CASE, 28 VIN, 100% LOAD, FREE RUN, UNLESS OTHERWISE SPECIFIED.

SINGLE OUTPUT MODELS		SMTR283R3S			SMTR2805S			UNITS
PARAMETER	CONDITIONS	MIN	TYP	MAX	MIN	TYP	MAX	
OUTPUT VOLTAGE		3.201	3.3	3.399	4.85	5.00	5.15	V
OUTPUT CURRENT	$V_{IN} = 16$ TO 40 V	0	—	5.45	0	—	5.0	A
OUTPUT POWER	$V_{IN} = 16$ TO 40 V	—	—	18	0	—	25	W
OUTPUT RIPPLE	$T_C = 25^\circ\text{C}$	—	20	40	—	20	50	mV p-p
10 kHz - 2 MHz	$T_C = -55^\circ\text{C}$ TO $+125^\circ\text{C}$	—	—	50	—	—	90	
LINE REGULATION ²	$V_{IN} = 16$ TO 40 V	—	0	20	—	10	50	mV
LOAD REGULATION	NO LOAD TO FULL	—	2	20	—	10	50	mV
INPUT VOLTAGE	CONTINUOUS	16	28	40	16	28	40	V
NO LOAD TO FULL	TRANSIENT 50 ms ¹	—	—	50	—	—	50	V
INPUT CURRENT	NO LOAD	—	30	75	—	35	75	mA
	INHIBITED	—	—	8	—	—	8	
INPUT RIPPLE CURRENT ³	10 kHz - 10 MHz	—	25	50	—	25	50	mA p-p
EFFICIENCY	$T_C = 25^\circ\text{C}$	70	73	—	74	78	—	%
	$T_C = -55^\circ\text{C}$ TO $+125^\circ\text{C}$	66	—	—	71	—	—	
LOAD FAULT ⁴	POWER DISSIPATION	—	—	12	—	—	14	W
SHORT CIRCUIT	RECOVERY ¹	—	—	6	—	—	5	ms
STEP LOAD RESPONSE ⁵	TRANSIENT	—	± 130	± 300	—	± 180	± 300	mV pk
0% - 100% - 50%	RECOVERY	—	—	200	—	—	200	μs
STEP LINE RESPONSE ^{1, 5}	TRANSIENT	—	—	± 300	—	—	± 300	mV pk
$V_{IN} 16 - 40 - 16$ V	RECOVERY	—	—	300	—	—	300	μs
START-UP ⁶	DELAY	—	—	5	—	—	5	ms
FULL LOAD	OVERSHOOT	—	0	50	—	0	50	mV pk
CAPACITIVE LOAD ¹	NO EFFECT ON DC	—	—	3000	—	—	3000	μF
$T_C = 25^\circ\text{C}$	PERFORMANCE	—	—	3000	—	—	3000	

Notes

1. Guaranteed by characterization test and/or analysis. Not a production test.
2. Operation is limited below 16 V (see Figure 22 on page 10).
3. Tested with 6800 pF ceramic bypass capacitor connected externally from input common to case.
4. Short circuit protection not guaranteed above 125°C case temperature.
5. Recovery time is measured from application of the transient to the point at which V_{OUT} is within 1% of final value.
6. Tested on release from inhibit.

SMTR Single and Dual DC-DC Converters

28 VOLT INPUT – 30 WATT

TABLE 7: ELECTRICAL CHARACTERISTICS: -55°C TO +125°C CASE, 28 VIN, 100% LOAD, FREE RUN, UNLESS OTHERWISE SPECIFIED.

SINGLE OUTPUT MODELS		SMTR2812S			SMTR2815S			UNITS
PARAMETER	CONDITIONS	MIN	TYP	MAX	MIN	TYP	MAX	
OUTPUT VOLTAGE		11.64	12.00	12.36	14.70	15.00	15.30	V
OUTPUT CURRENT	V _{IN} = 16 TO 40 V	0	—	2.5	0	—	2.0	A
OUTPUT POWER	V _{IN} = 16 TO 40 V	0	—	30	0	—	30	W
OUTPUT RIPPLE 10 kHz - 2 MHz	T _C = 25°C	—	15	40	—	15	40	mV p-p
	T _C = -55°C TO +125°C	—	—	90	—	—	90	
LINE REGULATION ²	V _{IN} = 16 TO 40 V	—	10	50	—	10	50	mV
LOAD REGULATION	NO LOAD TO FULL	—	20	50	—	10	50	mV
INPUT VOLTAGE	CONTINUOUS	16	28	40	16	28	40	V
NO LOAD TO FULL	TRANSIENT 50 ms ¹	—	—	50	—	—	50	V
INPUT CURRENT	NO LOAD	—	35	75	—	35	75	mA
	INHIBITED	—	—	8	—	—	8	
INPUT RIPPLE CURRENT ³	10 kHz - 10 MHz	—	35	50	—	35	50	mA p-p
EFFICIENCY	T _C = 25°C	78	83	—	79	83	—	%
	T _C = -55°C TO +125°C	75	—	—	76	—	—	
LOAD FAULT ⁴	POWER DISSIPATION	—	—	12	—	—	12	W
SHORT CIRCUIT	RECOVERY ¹	—	—	5	—	—	5	ms
STEP LOAD RESPONSE ⁵ 50% - 100% - 50%	TRANSIENT	—	±270	±400	—	±310	±500	mV pk
	RECOVERY	—	—	200	—	—	200	μs
STEP LINE RESPONSE ^{1, 5} 16 - 40 - 16 V	TRANSIENT	—	—	±500	—	—	±600	mV pk
	RECOVERY	—	—	300	—	—	300	μs
START-UP ⁶	DELAY	—	—	5	—	—	5	m sec
FULL LOAD	OVERSHOOT	—	0	120	—	0	150	mV pk
CAPACITIVE LOAD ¹ T _C = 25°C	NO EFFECT ON DC	—	—	3000	—	—	3000	μF
	PERFORMANCE	—	—	3000	—	—	3000	

Notes

- Guaranteed by characterization test and/or analysis. Not a production test.
- Operation is limited below 16 V (see Figure 22 on page 10).
- Tested with 6800 pF ceramic bypass capacitor connected externally from input common to case.
- Short circuit protection not guaranteed above 125°C case temperature.
- Recovery time is measured from application of the transient to the point at which V_{OUT} is within 1% of final value.
- Tested on release from inhibit.

SMTR Single and Dual DC-DC Converters

28 VOLT INPUT – 30 WATT

TABLE 8: ELECTRICAL CHARACTERISTICS: -55°C TO +125°C CASE, 28 VIN, 100% LOAD, FREE RUN, UNLESS OTHERWISE SPECIFIED.

DUAL OUTPUT MODELS		SMTR2805D			SMTR2812D			SMTR2815D			UNITS
PARAMETER	CONDITIONS	MIN	TYP	MAX	MIN	TYP	MAX	MIN	TYP	MAX	
OUTPUT VOLTAGE	+ V _{OUT}	4.85	5.00	5.15	11.64	12.00	12.36	14.55	15.00	15.45	V
	- V _{OUT}	4.82	5.00	5.18	11.58	12.00	12.42	14.47	15.00	15.53	
OUTPUT CURRENT ^{2,3} V _{IN} = 16 TO 40 V	EITHER OUTPUT	0	2.5	4.5 ¹	0	1.25	2.25 ¹	0	1.00	1.80 ¹	A
	TOTAL OUTPUT	—	—	5	—	—	2.5	—	—	2.00	
OUTPUT POWER ^{2,3} V _{IN} = 16 TO 40 V	EITHER OUTPUT	0	12.5	22.5 ¹	0	15	27 ¹	0	15	27 ¹	W
	TOTAL OUTPUT	—	—	25	—	—	30	—	—	30	
OUTPUT RIPPLE 10 kHz - 2 MHz ± V _{OUT}	T _C = 25°C	—	20	50	—	30	120	—	25	80	mV p-p
	T _C = -55°C TO +125°C	—	—	90	—	—	150	—	—	120	
LINE REGULATION ⁴ V _{IN} = 16 TO 40 V	+ V _{OUT}	—	0	50	—	0	50	—	0	50	mV
	- V _{OUT}	—	10	100	—	15	150	—	10	180	
LOAD REGULATION NO LOAD TO FULL	+ V _{OUT}	—	5	50	—	5	50	—	—	50	mV
	- V _{OUT}	—	15	100	—	30	150	—	—	180	
CROSS REGULATION	SEE NOTE 5	—	—	12	—	—	8.3	—	—	8	%
EFFECT ON -V _{OUT} , 25°C	SEE NOTE 6	—	—	12	—	—	8.3	—	—	8	
INPUT VOLTAGE NO LOAD TO FULL	CONTINUOUS	16	28	40	16	28	40	16	28	40	V
	TRANSIENT 50 ms ¹	0	—	50	0	—	50	0	—	50	
INPUT CURRENT	NO LOAD	—	28	75	—	40	75	—	48	75	mA
	INHIBITED	—	—	8	—	—	8	—	—	8	
INPUT RIPPLE CURRENT ⁷	10 kHz - 10 MHz	—	25	50	—	35	50	—	35	50	mA p-p
EFFICIENCY BALANCED LOAD	T _C = 25°C	74	76	—	77	80	—	78	81	—	%
	T _C = -55°C TO +125°C	72	—	—	75	—	—	75	—	—	
LOAD FAULT ⁸	POWER DISSIPATION	—	8	12	—	6	12	—	5	12	W
SHORT CIRCUIT	RECOVERY ¹	—	—	5.0	—	—	5.0	—	—	5.0	ms
STEP LOAD RESPONSE ⁹ 50% - 100% - 50% ± V _{OUT}	TRANSIENT	—	±150	±300	—	±200	±300	—	±220	±400	mV pk
	RECOVERY	—	—	200	—	—	200	—	—	200	
STEP LINE RESPONSE ^{1,9} 16 - 40 -16 V ± V _{OUT}	TRANSIENT	—	—	±400	—	—	±400	—	—	±500	mV pk
	RECOVERY	—	—	300	—	—	300	—	—	300	
START-UP ¹⁰	DELAY	—	—	5	—	—	5	—	—	5	ms
FULL LOAD	OVERSHOOT ¹	—	0	180	—	0	150	—	0	150	mV pk
CAPACITIVE LOAD ¹ T _C = 25°C	NO EFFECT ON DC PERFORMANCE	—	—	3000	—	—	3000	—	—	3000	μF

Notes

1. Guaranteed by characterization test and/or analysis. Not a production test.
2. The specified max current is available from either output.
3. Up to 90% of the total output current/power is available from either output providing the opposite output is carrying at least 10% of the total output power.
4. Operation is limited below 16 V (see Figure 22 on page 10).
5. Effect on the negative output under the following conditions:
+P_{OUT} 20% to 80%; -P_{OUT} 80% to 20%.

6. Effect on the negative output under the following conditions:
+P_{OUT} 50%; -P_{OUT} 10% to 50%. See Figure 21 on page 10.
7. Tested with 6800 pF ceramic bypass capacitor connected externally from input common to case.
8. Indefinite short circuit protection not guaranteed above 125°C case temperature.
9. Recovery time is measured from application of the transient to point at which V_{OUT} is within 1% of final value.
10. Tested on release from inhibit.

SMTR Single and Dual DC-DC Converters

28 VOLT INPUT – 30 WATT

TYPICAL PERFORMANCE PLOTS:

28 V_{IN}, 25°C T_C, 100% LOAD, FREE RUN, UNLESS OTHERWISE SPECIFIED.
 These are examples for reference only and are not guaranteed specifications.

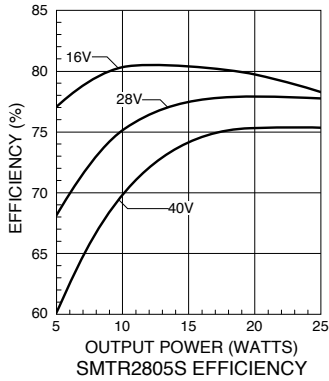

FIGURE 6

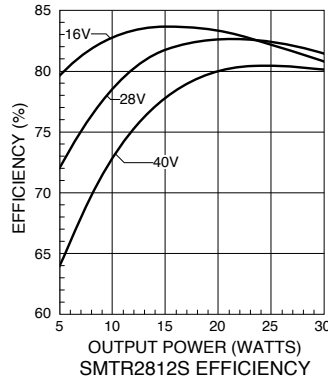

FIGURE 7

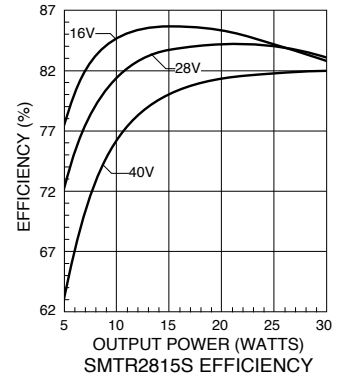

FIGURE 8

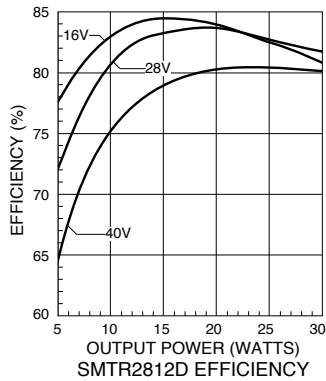

FIGURE 9

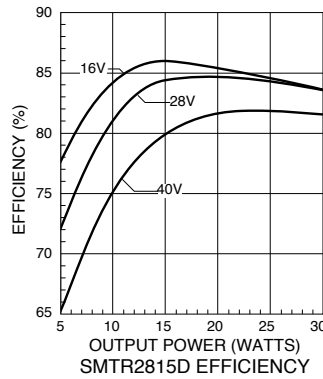

FIGURE 10

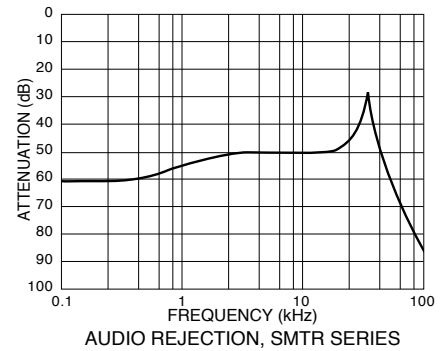

FIGURE 11

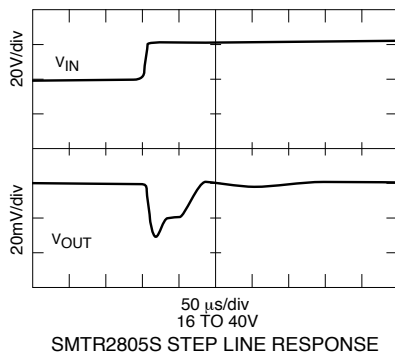

FIGURE 12

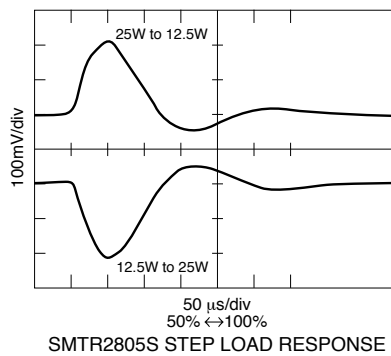

FIGURE 13

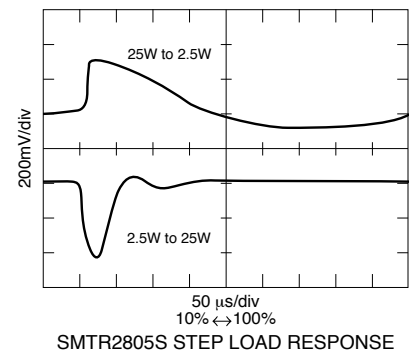

FIGURE 14

SMTR Single and Dual DC-DC Converters

28 VOLT INPUT – 30 WATT

TYPICAL PERFORMANCE PLOTS:

28 V_{IN}, 25°C T_C, 100% LOAD, FREE RUN, UNLESS OTHERWISE SPECIFIED.
 These are examples for reference only and are not guaranteed specifications.

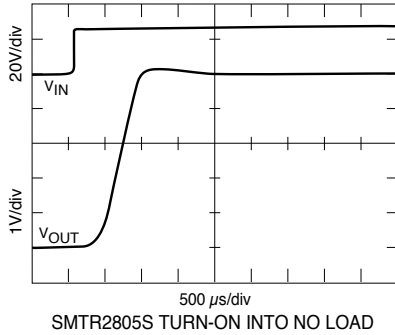

FIGURE 15

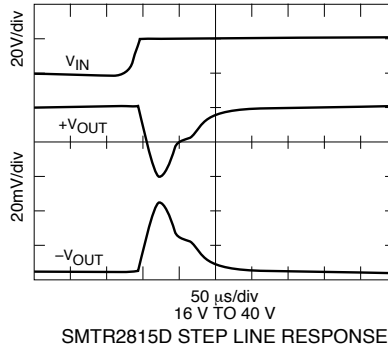

FIGURE 16

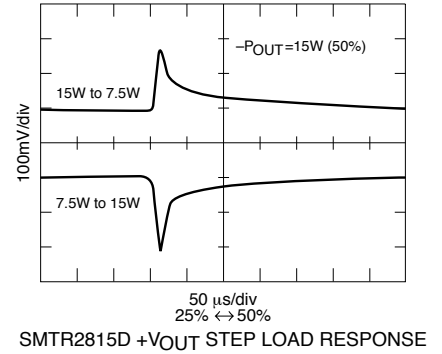

FIGURE 17¹

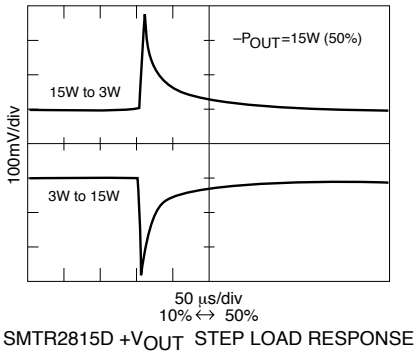

FIGURE 18¹

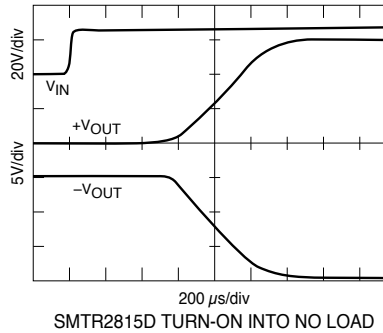

FIGURE 19

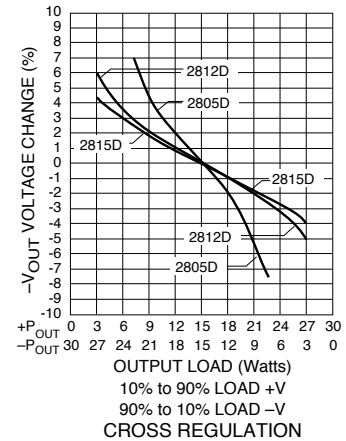

FIGURE 20¹

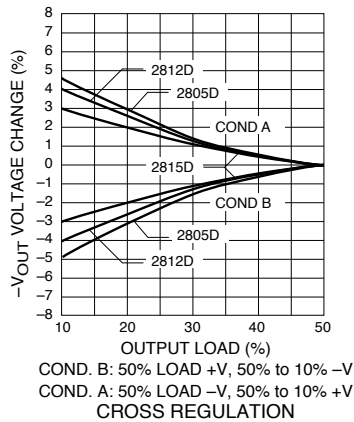

FIGURE 21¹

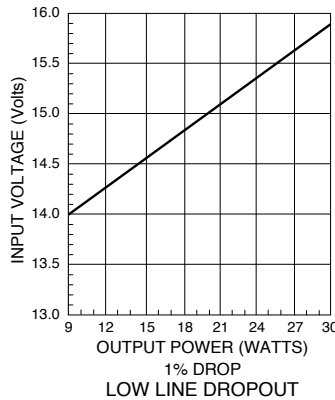

FIGURE 22

Notes 1. Percent (%) of power refers to the percent of the total output power of the converter.

SMTR Single and Dual DC-DC Converters

28 VOLT INPUT – 30 WATT

BOTTOM VIEW CASE H2

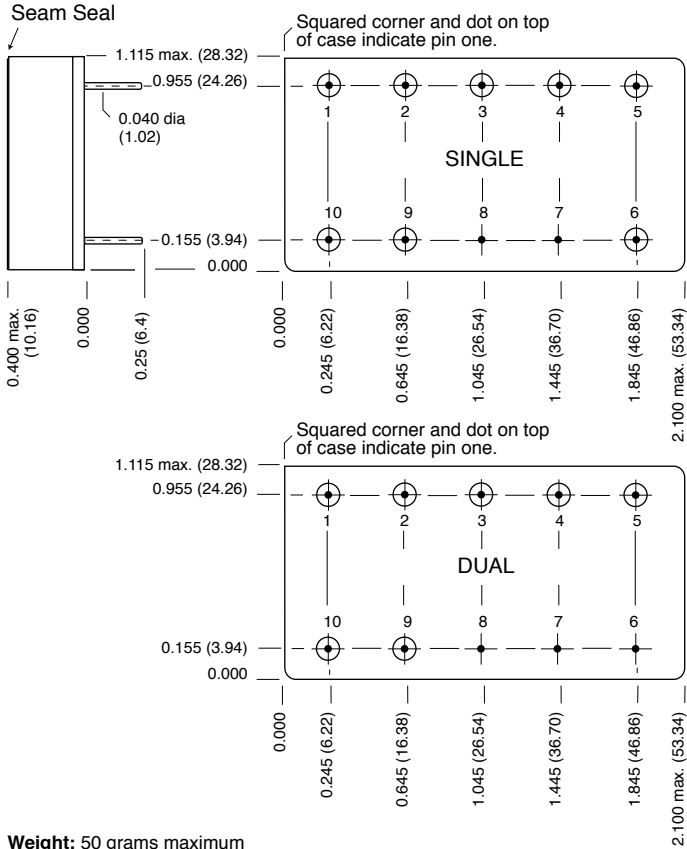

Weight: 50 grams maximum

Case dimensions in inches (mm)
Tolerance ±0.005 (0.13) for three decimal places
±0.01 (0.3) for two decimal places
unless otherwise specified

CAUTION
Heat from reflow or wave soldering may damage the device.
Solder pins individually with heat application not exceeding 300°C for 10 seconds per pin.

Materials
Header Cold Rolled Steel/Nickel/Gold
Cover Kovar/Nickel
Pins #52 alloy/Gold ceramic seal
Gold plating of 50 - 150 microinches is included in pin diameter
Seal hole 0.120 ±0.002 (3.05 ± 0.05)

Case H2 SMTR S/D, Rev K, 2014.01.13
Please refer to the numerical dimensions for accuracy.

Figure 23: Cases H2

SMTR Single and Dual DC-DC Converters

28 VOLT INPUT – 30 WATT

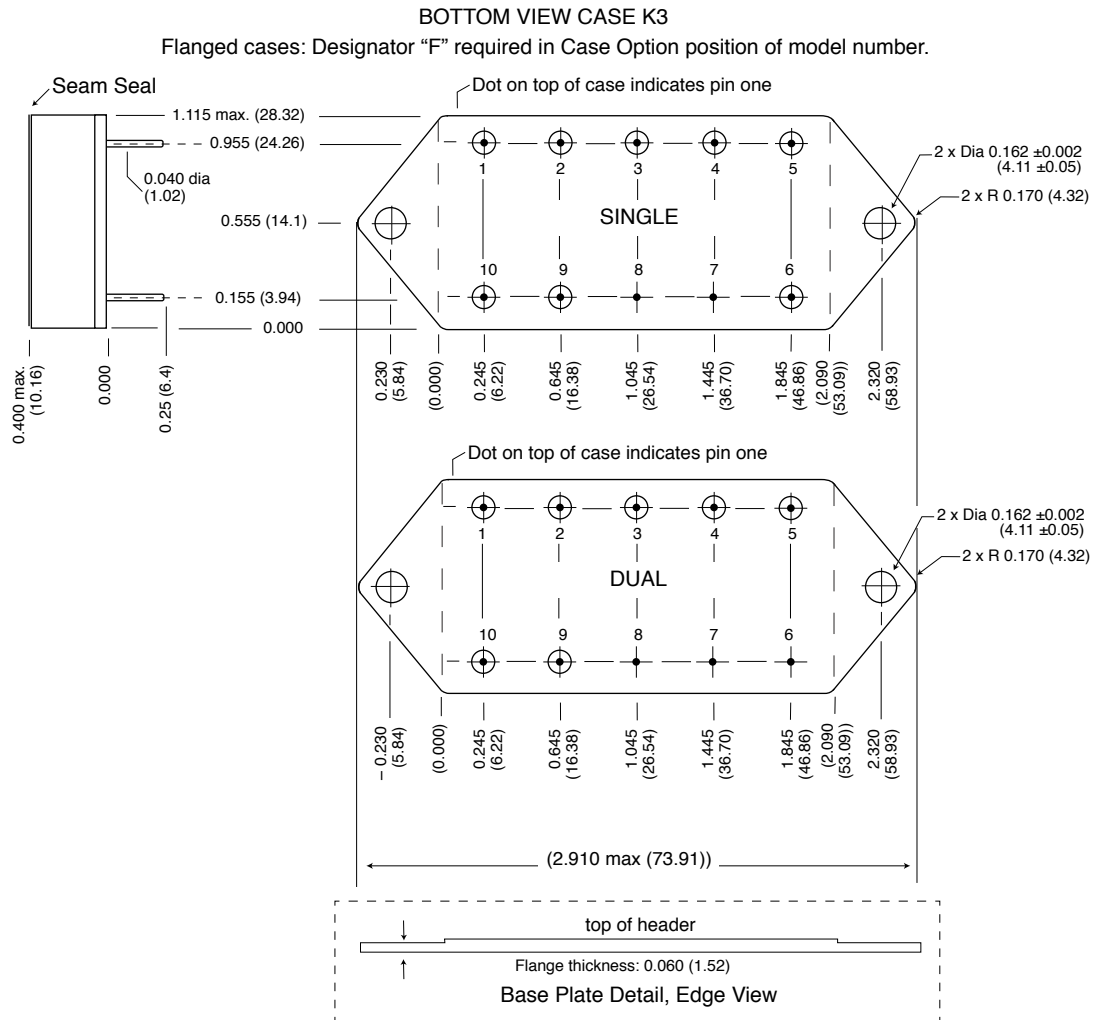

Weight: 52 grams maximum

Case dimensions in inches (mm)

Tolerance ± 0.005 (0.13) for three decimal places
 ± 0.01 (0.3) for two decimal places
 unless otherwise specified

CAUTION

Heat from reflow or wave soldering may damage the device. Solder pins individually with heat application not exceeding 300°C for 10 seconds per pin.

Materials

Header Cold Rolled Steel/Nickel/Gold
 Cover Kovar/Nickel
 Pins #52 alloy/Gold, ceramic seal
 Gold plating of 50 - 150 microinches included in pin diameter
 Seal hole 0.120 ± 0.002 (3.04 ± 0.05)

Case K3 SMTR SD F, Rev L, 2014.12.10
 Please refer to the numerical dimensions for accuracy.

FIGURE 24: CASES K3

SMTR Single and Dual DC-DC Converters

28 VOLT INPUT – 30 WATT

ELEMENT EVALUATION SPACE DC-DC CONVERTERS PROTOTYPE, CLASS H AND CLASS K

COMPONENT-LEVEL TEST PERFORMED	NON-QML ¹	QML			
	PROTOTYPE	CLASS H		CLASS K	
	/O	/H		/K	
	M/S ²	M/S ²	P ³	M/S ²	P ³
Element Electrical	■	■	■	■	■
Visual		■	■	■	■
Internal Visual		■		■	
Temperature Cycling				■	■
Constant Acceleration				■	■
Interim Electrical				■	
Burn-in				■	
Post Burn-in Electrical				■	
Steady State Life				■	
Voltage Conditioning Aging					■
Visual Inspection					■
Final Electrical		■	■	■	■
Wire Bond Evaluation		■	■	■	■
SEM				■	

Notes

1. Non-QML products may not meet all of the requirements of MIL-PRF-38534.
2. M/S = Active components (microcircuit and semiconductor die)
3. P = Passive components, Class H and K element evaluation. Not applicable to space prototype ("O") element evaluation.

Definitions:

Element Evaluation: Component testing/screening per MIL-STD-883 as determined by MIL-PRF-38534
SEM: scanning electron microscopy

TABLE 9: ELEMENT EVALUATION

SMTR Single and Dual DC-DC Converters

28 VOLT INPUT – 30 WATT

ENVIRONMENTAL SCREENING SPACE DC-DC CONVERTERS PROTOTYPE, CLASS H AND CLASS K, RHA ¹ P, L AND R

TEST PERFORMED	NON-QML ²	QML ³					
	PROTOTYPE	CLASS H			CLASS K		
	/OO ⁴	/HP	/HL	/HR	/KP	/KL	/KR
Non-destruct wire bond pull, Method 2023		■ ⁵	■ ⁵	■ ⁵	■	■	■
Pre-cap Inspection, Method 2017, 2032	■	■	■	■	■	■	■
Temperature Cycle (10 times) (Qual 100 times) Method 1010, Cond. C, -65°C to +150°C, ambient	■	■	■	■	■	■	■
Constant Acceleration Method 2001, 3000 g (Qual 5000 g)	■	■	■	■	■	■	■
PIND, Test Method 2020, Cond. A		■ ⁵	■ ⁵	■ ⁵	■	■	■
Pre burn-in test, Group A, Subgroups 1 and 4	■	■ ⁵	■ ⁵	■ ⁵	■	■	■
Burn-in Method 1015, +125°C case, typical ⁶							
96 hours	■						
160 hours		■	■	■			
2 x 160 hours (includes mid-BI test)					■	■	■
Final Electrical Test, MIL-PRF-38534, Group A,							
Subgroups 1 and 4: +25°C case	■						
Subgroups 1 through 6, -55°C, +25°C, +125°C case		■	■	■	■	■	■
Hermeticity Test, Method 1014							
Gross Leak, Cond. B ₂ , Kr85					■	■	■
Gross Leak, Cond. C ₁ , fluorocarbon	■	■	■	■			
Fine Leak, Cond. B ₁ , Kr85					■	■	■
Fine Leak, Cond. A ₂ , helium	■	■	■	■			
Radiography, Method 2012					■	■	■
Post Radiography Electrical Test, +25°C case					■ ⁵	■ ⁵	■ ⁵
Final visual inspection, Method 2009	■	■	■	■	■	■	■
RHA P: 30 krad(Si) total dose ^{1, 7, 8}		■			■		
RHA L: 50 krad(Si) total dose ^{1, 7, 8}			■			■	
RHA R: 100 krad(Si) total dose ^{1, 7, 8}				■			■
SEE, LET 86 MeV cm²/mg ^{1, 9}		■	■	■	■	■	■

Test methods are referenced to MIL-STD-883 as determined by MIL-PRF-38534.

- Notes
1. Our Redmond facility has a DLA approved RHA plan for Interpoint power products. Our SMD products with RHA "P", "L" or "R" code meet DLA requirements.
 2. Non-QML prototype products may not meet all of the requirements of MIL-PRF-38534.
 3. All processes are QML qualified and performed by certified operators.
 4. "O" in the RHA designator position in Interpoint model numbers indicates DLA RHA "-" defined as no RHA.
 5. Not required by DLA but performed to assure product quality.
 6. Burn-in temperature designed to bring the case temperature to +125°C minimum. Burn-in is a powered test.
 7. High dose rate test.
 8. Low dose rate test.
 9. No destructive events or SEL.

TABLE 10: ENVIRONMENTAL SCREENING AND RHA LEVELS

