

SMRT Single, Dual and Triple Space DC-DC Converters

19 TO 56 VOLT INPUT – 23 TO 35 WATT – SPACE QUALIFIED

FEATURES

- Radiation tolerant space DC-DC converter
 - Single event effects (SEE) LET performance to 86 MeV cm²/mg
 - Total ionizing dose (TID) guaranteed per MIL-STD-883 method 1019, radiation hardness assurance (RHA) P = 30 krad(Si), L = 50 krad(Si), R = 100 krad(Si)
 - 50 - 300 rad(Si)/sec dose rate (Condition A)
 - 10 mrad(Si)/sec dose rate (Condition D)
- Built in MIL-STD-461 EMI filter
- Output trim from 51% to 125% of nominal
- Operating temperature -55° to +125°C
- Qualified to MIL-PRF-38534 Class E
- Input voltage range 19 to 56 volts
- Transient protection 80 volts for 120 ms
- Fully isolated, 5 port isolation
- Magnetic feedback
- Fixed high frequency switching
- Remote sense
- Inhibit function
- Synchronization input
- Indefinite short circuit protection
- Meets MIL-STD-704A transient standards
- Soft-start function limits inrush current during start-up

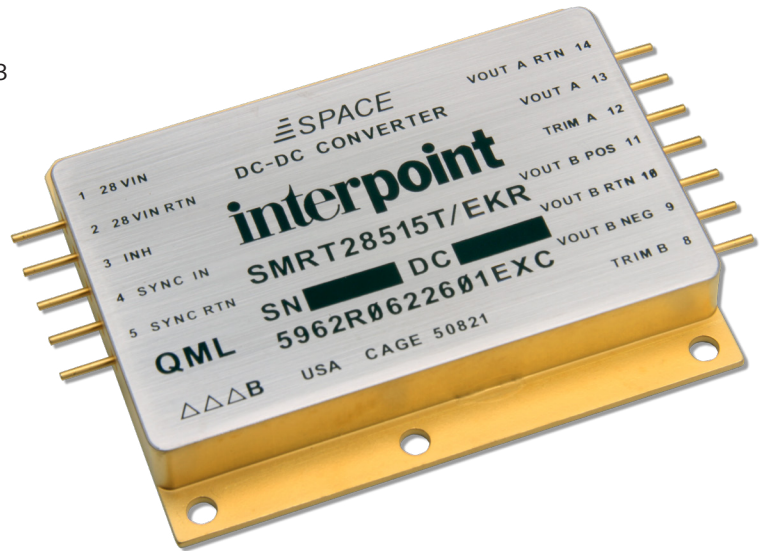

MODELS		
OUTPUT VOLTAGE (V)		
SINGLE	DUAL	TRIPLE
3.3	Vout A 5 V, Vout B 5 V	+3.3 & ±12
5	Vout A 5 V, Vout B 12 V ¹	+3.3 & ±15
8.7	Vout A 5 V, Vout B 15 V ¹	+5 & ±7
12	Vout A 12 V, Vout B 12 V	+5 & ±12
15	Vout A 15 V, Vout B 15 V	+5 & ±15

1. "Vout A 5 V, Vout B 12 V" and "Vout A 5 V, Vout B 15 V" are configured from the SMRT28507T triple output model. Please see "Triple Output Models Configured as Dual Outputs" on page 3.

DESCRIPTION

The Interpoint® SMRT Series™ of DC-DC converters offers up to 35 watts of power in a radiation tolerant design. The low profile SMRT converters are manufactured in our fully certified and qualified MIL-PRF-38534 Class K production facility and packaged in hermetically sealed steel cases. They are ideal for use in programs requiring high reliability, small size, and high levels of radiation hardness assurance.

The SMRT converters are switching regulators which use a two-phase, phase shifted flyback design with a nominal switching frequency of 300 kHz. Tight regulation is maintained with advanced constant frequency pulse width modulation design techniques. The SMRT's feed-forward compensation and discontinuous topologies provide high levels of input-to-output ripple rejection. See Figure 20 on page 33, Figure 35 and Figure 36 on page 36 and Figure 55 and Figure 56 on page 41.

Two independent feedback loops are used to regulate the dual and triple outputs, one feedback loop regulates the two-phased single output. Each set of outputs is electrically isolated from the other and from the input. This product configuration eliminates cross regulation effects between output sets.

Configurations:

- Single Output: One dual-phase output
- Dual Output: Two isolated single-phase outputs
- Dual Output configured from a triple: Main output is one voltage, the auxiliaries are spanned for double the auxiliary output. Refer to "Triple Output Models Configured as Dual Outputs" on page 3.
- Triple Output: One single-phased output (Main) isolated from one single-phase dual output (± Auxiliary)

SMRT Single, Dual and Triple Space DC-DC Converters

19 TO 56 VOLT INPUT – 23 TO 35 WATT – SPACE QUALIFIED

UNDERVOLTAGE LOCKOUT

The converters have an undervoltage lockout that will allow power conversion at approximately 17 volts on a rising input voltage and a conversion shut-down on a falling voltage at approximately 14.5 volts.

INHIBIT FUNCTION

The SMRT Series incorporates an inhibit terminal that can be used to disable internal switching. It is not recommended to tie the Inhibit pin of an SMRT directly to the Inhibit pin of another converter as the SMRT Inhibit pin can sink current. When pulling multiple inhibit signals low, a separate interface is recommended for each SMRT. The converter is inhibited when the Inhibit pin is pulled low (0.4 volts). In the inhibit mode the inhibit pin current requirement is less than ~2 mA. The converter resumes normal operation when an open circuit is applied to the Inhibit pin or the Inhibit pin is open (unconnected). The open circuit voltage of the Inhibit pin is 5 to 6 volts. To enable the converter use an open collector on the Inhibit pin or leave it unconnected.

SYNCHRONIZATION

The Sync Input pin is isolated which allows Sync Return pin to be tied to the primary side, secondary side, or float with respect to all inputs and outputs. Input current into this pin is limited by a series 1 k ohm resistance.

RADIATION TOLERANCE

The SMRT DC-DC converters are designed to provide continuous normal operation through radiation levels associated with space missions and in tactical and strategic military environments. The RHA level R converters will operate normally in radiation environments with up to 100 krad(Si) total dose and will not exhibit low dose rate (LDR) effects at 10 mrad(Si)/sec dose rate up to a TID of 100 krad.

These levels of radiation tolerance make the SMRT converters suitable for electronics in programs where operation in high radiation environments is required.

SCREENING

SMRT converters offer screening options to space prototype (O), or Class E and radiation hardness assurance (RHA) levels P - 30 krad(Si), L - 50 krad(Si) or R - 100 krad(Si). Single event effects (SEE) LET performance to 86 MeV cm²/mg. See Table 27 through Table 29 for more information.

EMI

The SMRT has a built-in EMI input filter which brings the conducted emissions into compliance with both methods of MIL-STD-461, revisions C-CE03 and D-/E-/F-CE102.

ELECTROSTATIC DISCHARGE (ESD) SENSITIVITY

Per MIL-PRF-38534, the SMRT Series converters are rated to ESD class 3B defined as sensitivity equal to, or greater than, 8000 volts.

SENSE

Tight load regulation is maintained via wide bandwidth magnetic feedback and through the use of remote sense on single output models and V_{OUT} A on dual output models. The sense pin function allows a remote connection for the voltage regulation circuit to compensate for voltage drops between the converter and the point of use.

Note that if the sense pins are connected but the output voltage pins are not, the converter may be damaged.

The maximum voltage drop from the output to the sense pin is shown in Table 1 below.

NOMINAL OUTPUT VOLTAGE (V) ¹	MAX VOLTAGE DROP (V)	MAX VOLTAGE AT CONVERTER (V _{MAX}) ¹
3.3 ²	0.58	3.88
5	1.0	6.0
8.7 ²	1.9	10.58
12	2.68	14.68
15	3.36	18.36

TABLE 1: MAXIMUM VOLTAGE DROP USING REMOTE SENSE
SINGLE AND DUAL MODELS ONLY

Notes

1. Do not exceed maximum voltage.
2. The sense pin function for 3.3 and 8.7 is only available on single output models.

SMRT Single, Dual and Triple Space DC-DC Converters

19 TO 56 VOLT INPUT – 23 TO 35 WATT – SPACE QUALIFIED

OUTPUT VOLTAGE TRIM

There are two possible methods for output voltage trim. Trim can be achieved using the provided trim pin or in some cases the sense pin. The preferred method is the use of the trim pin. Every converter in the SMRT family provides a trim pin that allows at least one output to be adjusted. See Table 3 and Table 4 for maximum adjust range for each output voltage. The single output models provide a trim pin and remote sense. The dual output models allow remote sense on $V_{OUT A}$ and have a trim pin on the $V_{OUT B}$. The triples have a trim pin on the $V_{OUT A}$ (main) and a single trim pin for both $V_{OUT B}$ auxiliaries.

For outputs without a trim pin, the output at the converter can be adjusted up by adding resistance in series with the sense pin.

See Table 2 for a summary of trim features and see below for details on the trim features. See Formula 1 for trimming down when using a trim pin, Formula 2 for trimming up when using a trim pin and Formula 3 when trimming up using Sense A pin on a dual output model.

NOTE: Do not exceed maximum current rating when trimming down.

NOTE: Do not exceed maximum power rating when trimming up.

Voltage Adjust Feature	Singles	Duals	Triples
Trim Pin (Formulas 1 and 2)	Trim and Sense Pin	Trim B	Trim A, Trim B \pm
Sense Pin (Formula 3)	—	Sense A	—

TABLE 2: TRIM AND SENSE VOLTAGE ADJUST

TRIPLE OUTPUT MODELS CONFIGURED AS DUAL OUTPUTS

The “Vout A 5 V, Vout B 12 V” and “Vout A 5 V, Vout B 15 V” are configured from the SMRT28507T triple output model. In addition to being used as a triple, the SMRT28507T can be configured as a dual. When used as a dual, the 5 volt output would be one output and the span voltage of the +/- 7 volt auxiliaries would be the other output.

The span voltage is the voltage across the auxiliaries. To achieve a +14 volt output, use the -7 volt output for system ground and the +7 volt output as the +14 volt output. Output common (pin 10) would be left floating (not connected to the load). To achieve a -14 volt output, use the +7 volt output as “system ground” and the -7 volt output as the -14 volt output. Output common (pin 10) would be left floating (not connected to the load).

Trim B (pin 8) trims both auxiliary outputs which can be trimmed to a desired voltage using the trim formulas in Table 3 or Table 4 on page 6. The 14 volt span voltage can be trimmed from approximately 11 to 16.4 volts using the trim function. When trimming use Figure 1 or Figure 2 for trim connections for Vout B based on the triple models.

When using the span voltage the maximum load capacitance across the span voltage is reduced to half the value stated in the Electrical Characteristics tables.

The auxiliary outputs of all triple models can be used in the same manner. The +/-12 volt auxiliary can be used to achieve 24 volts, and the +/-15 volt can be used to achieve 30 volts. The auxiliary outputs can then be trimmed to a more desirable value.

SMRT Single, Dual and Triple Space DC-DC Converters

19 TO 56 VOLT INPUT – 23 TO 35 WATT – SPACE QUALIFIED

OUTPUT VOLTAGE TRIM DETAILS TRIM DOWN

The output voltage trim pin function is implemented with a resistor between the trim pin and either the output voltage pin or the sense pin. Figure 1 show the connections for the trim resistor (R_T).

Caution: The sense pins must always be connected to all of the output voltage pins of the same polarity.

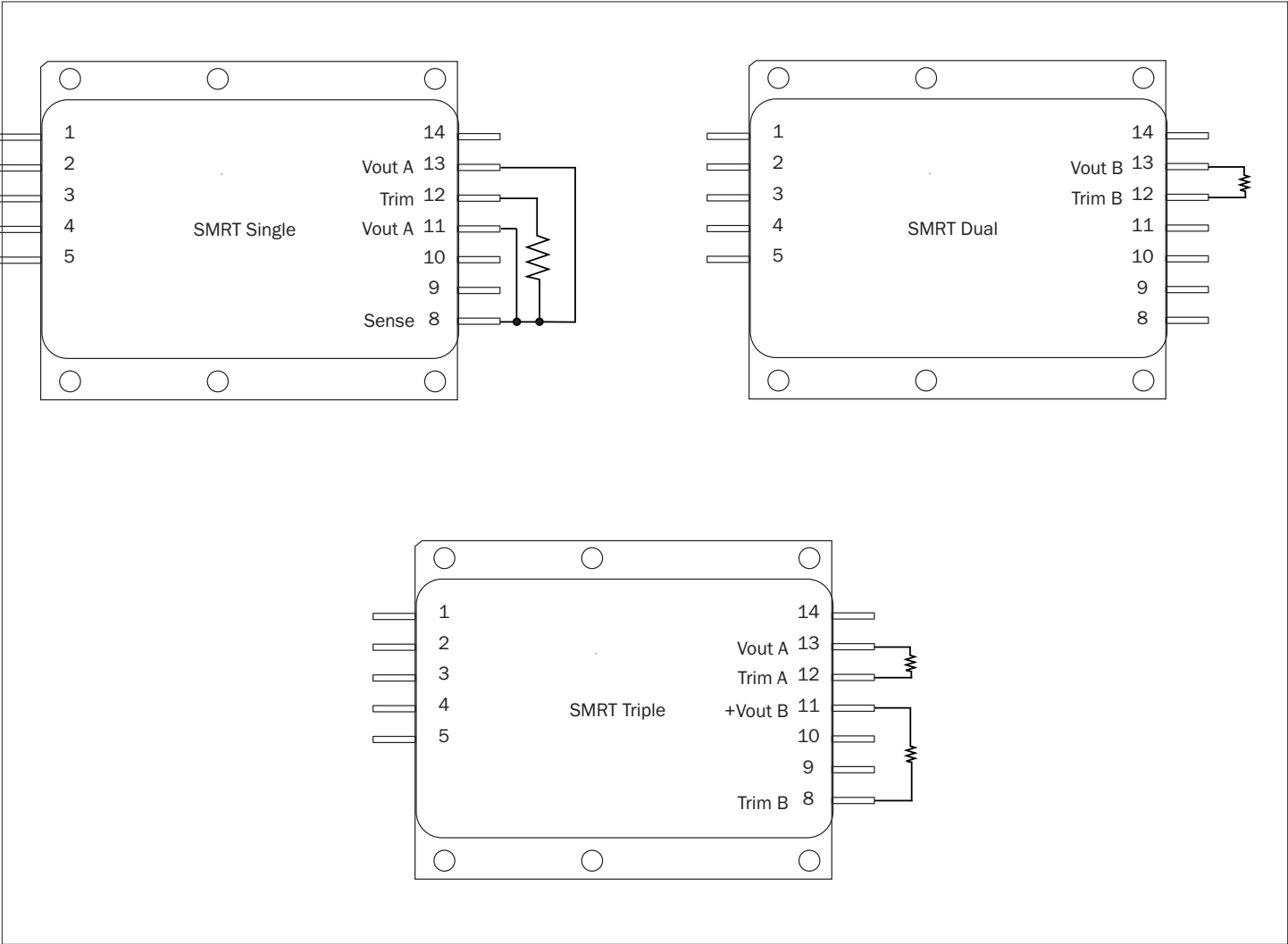

FIGURE 1: TRIM DOWN DIAGRAMS

For single output models, when trimming down, the Sense Return (pin 9) must be connected to Vout A Return (pins 10 and 14).

SMRT Single, Dual and Triple Space DC-DC Converters

19 TO 56 VOLT INPUT – 23 TO 35 WATT – SPACE QUALIFIED

OUTPUT VOLTAGE TRIM DETAILS TRIM UP

The output voltage trim pin function is implemented with a resistor between the trim pin and either the output voltage pin or the sense pin. Figure 2 show the connections for the trim resistor (R_T).

Caution: The sense pins must always be connected to all of the output voltage pins of the same polarity.

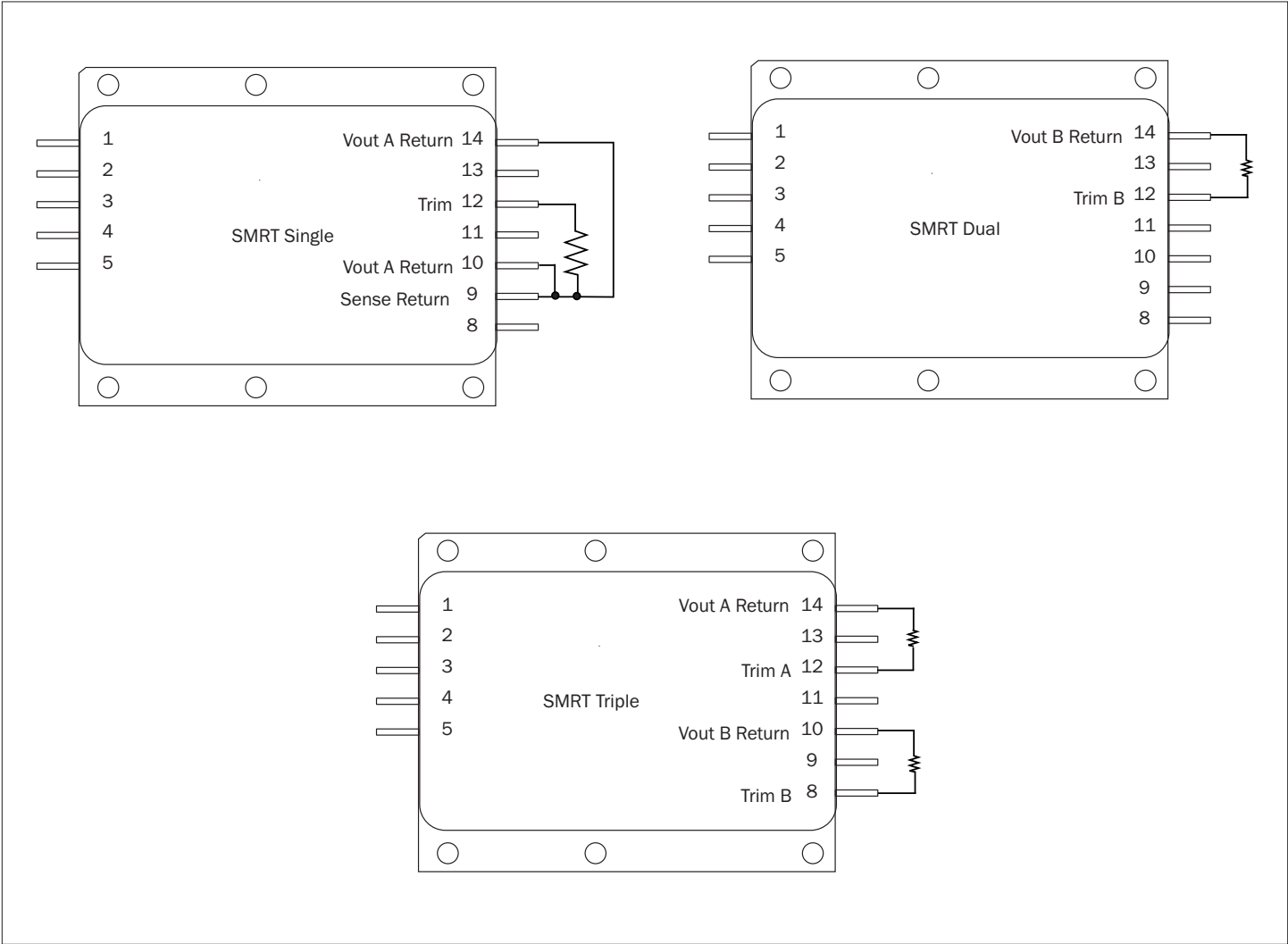

FIGURE 2: TRIM UP DIAGRAMS

For single output models, when trimming up, the Sense (pin 8) must be connected to Vout A (pins 11 and 13).

SMRT Single, Dual and Triple Space DC-DC Converters

19 TO 56 VOLT INPUT – 23 TO 35 WATT – SPACE QUALIFIED

OUTPUT VOLTAGE TRIM DETAILS (CONTINUED)

TRIM DOWN USING TRIM PIN, ALL MODELS

To trim the output voltage lower than the nominal set point, connect R_{TRIM} (R_T) as shown in Figure 1. The value of R_{TRIM} is calculated by the following equation:

V_{NOM}	R_{TRIM} (k)	V_{MIN}	% of V_{NOM}
3.3	3500	3.18	96
5 single and triple	4520	4.16	83
5 dual	7040	4.38	88
7	8020	5.47	78
8.7	9040	6.13	70
12	11030	7.05	58
15	12900	7.65	51

TABLE 3: TRIM DOWN CONSTANTS WHEN USING TRIM PIN

FORMULA 1: TRIM DOWN USING TRIM PIN

$$R_{TRIM} = K \left(V_{OUT} - V_{MIN} \right) / \left(V_{NOM} - V_{OUT} \right)$$

Where:

K = Multiplication constant from Table 3

V_{OUT} = Desired output voltage (must be greater than V_{MIN})

V_{MIN} = Minimum output voltage from Table 3

V_{NOM} = Nominal set point voltage of the converter

CAUTION:

-Do not exceed maximum current rating when trimming down.
 -Do not make any connections between TRIM B, pin 8, and VOUT B Negative, pin 9. Any connection between the two can cause the auxiliary voltages to go excessively high and can damage the converter.

TRIM UP USING TRIM PIN, ALL MODELS

To trim the output voltage higher than the nominal set point, connect R_{TRIM} as shown in Figure 2. The value of R_{TRIM} is calculated by the following equation:

V_{NOM}	R_{TRIM} (k)	V_{MAX}	% of V_{NOM}
3.3	3000	3.70	112
5 single and triple	3000	6.26	125
5 dual	5280	5.82	116
7	5300	8.27	118
8.7	5300	10.46	120
12	5300	14.69	122
15	5300	18.54	124

TABLE 4: TRIM UP CONSTANTS WHEN USING TRIM PIN

FORMULA 2: TRIM UP USING TRIM PIN

$$R_{TRIM} = K \left(V_{MAX} - V_{OUT} \right) / \left(V_{OUT} - V_{NOM} \right)$$

Where:

K = Multiplication constant from Table 4

V_{OUT} = Desired output voltage (must be less than V_{MAX})

V_{MAX} = Maximum output voltage from Table 4

V_{NOM} = Nominal set point voltage of the converter

CAUTION:

-Do not exceed maximum power rating when trimming up.
 -Do not make any connections between TRIM B, pin 8, and VOUT B Negative, pin 9. Any connection between the two can cause the auxiliary voltages to go excessively high and can damage the converter.

TRIM UP USING SENSE A PIN ON DUAL MODELS ONLY

Trim Up $V_{OUT A}$

In addition to remote sensing, the Sense A pin may be used to increase the regulated output voltage at the $V_{OUT A}$ pin. This is accomplished by attaching a resistor (R_{ADJUST}) between the Sense A (pin 8) and the $V_{OUT A}$ (pin 11). The value of R_{ADJUST} is calculated by the following equation:

V_{NOM}	R_{TRIM} (k)	V_{MAX}	% of V_{NOM}
5	1	6.00	120
12	0.98	12.98	108
15	1.134	16.13	107.5

TABLE 5: TRIM UP CONSTANTS WHEN USING SENSE PIN ON OUTPUT A OF DUAL OUTPUT MODELS

FORMULA 3: TRIM UP USING SENSE A PIN

$$R_{ADJUST} = 240 \left(V_{OUT} - V_{NOM} \right) / \left(K + \left(V_{NOM} - V_{OUT} \right) \right)$$

Where:

V_{OUT} = Desired output voltage (must be less than V_{MAX})

V_{NOM} = Nominal set point voltage of the converter

V_{MAX} = Maximum achievable output voltage

CAUTION:

Do not exceed maximum power rating when trimming up.

When using the Sense A (pin 8) to trim up, the Sense Return A (pin 9) must be connected to Vout Return A (pin 10).

SMRT Single, Dual and Triple Space DC-DC Converters

19 TO 56 VOLT INPUT - 23 TO 35 WATT - SPACE QUALIFIED

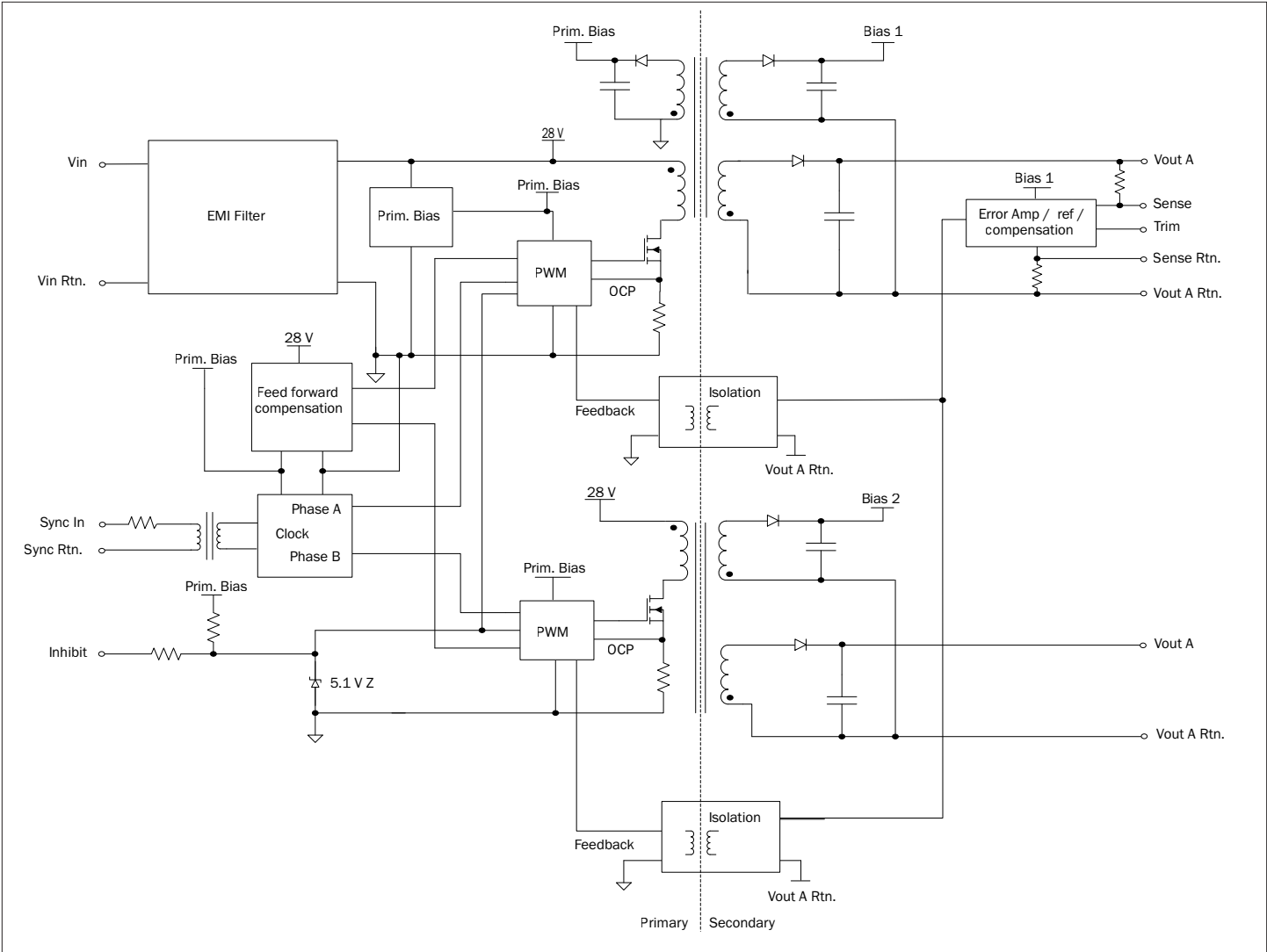

FIGURE 3: SMRT SINGLE BLOCK DIAGRAM

SMRT Single, Dual and Triple Space DC-DC Converters

19 TO 56 VOLT INPUT - 23 TO 35 WATT - SPACE QUALIFIED

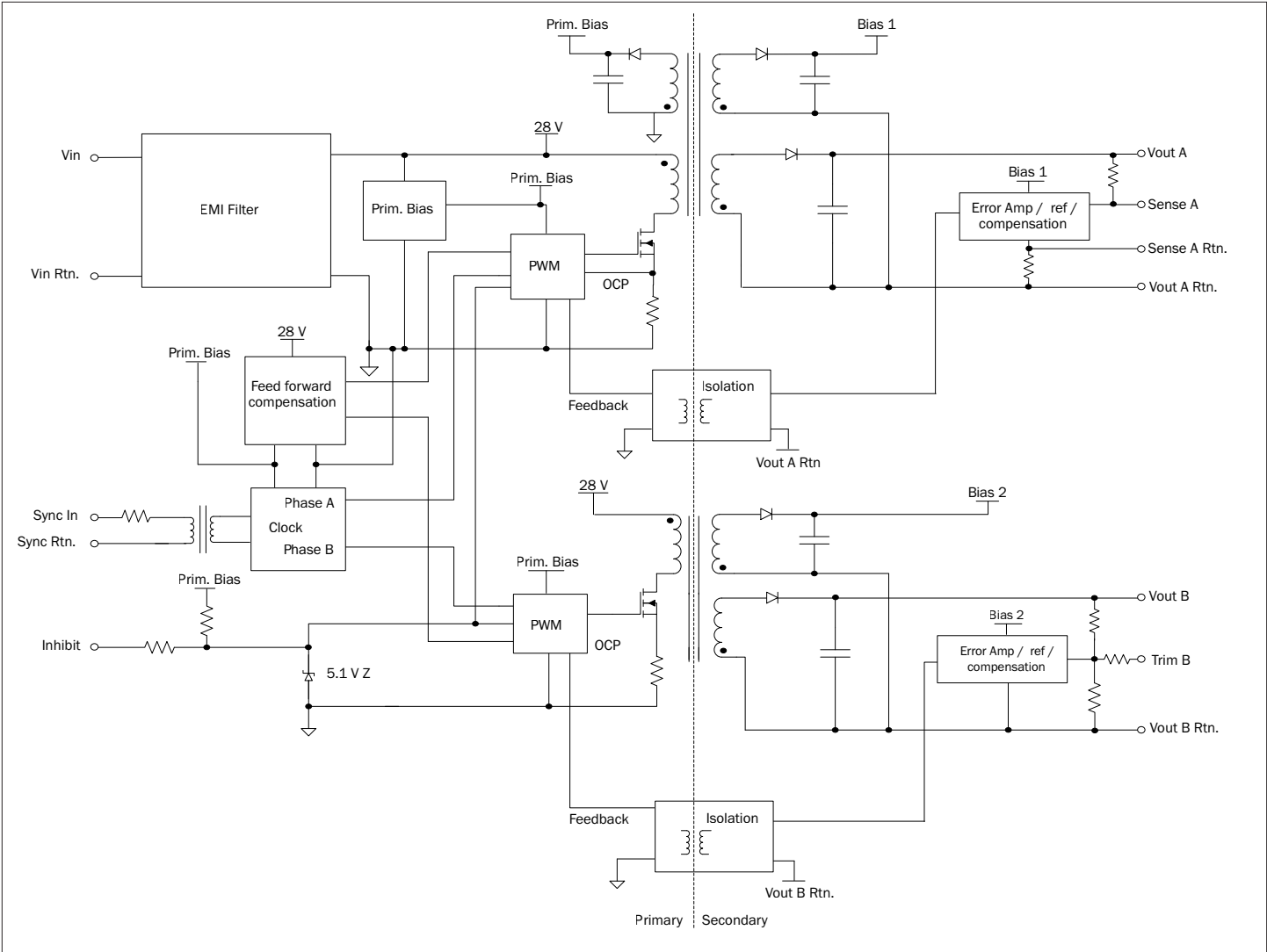

FIGURE 4: SMRT DUAL BLOCK DIAGRAM

SMRT Single, Dual and Triple Space DC-DC Converters

19 TO 56 VOLT INPUT - 23 TO 35 WATT - SPACE QUALIFIED

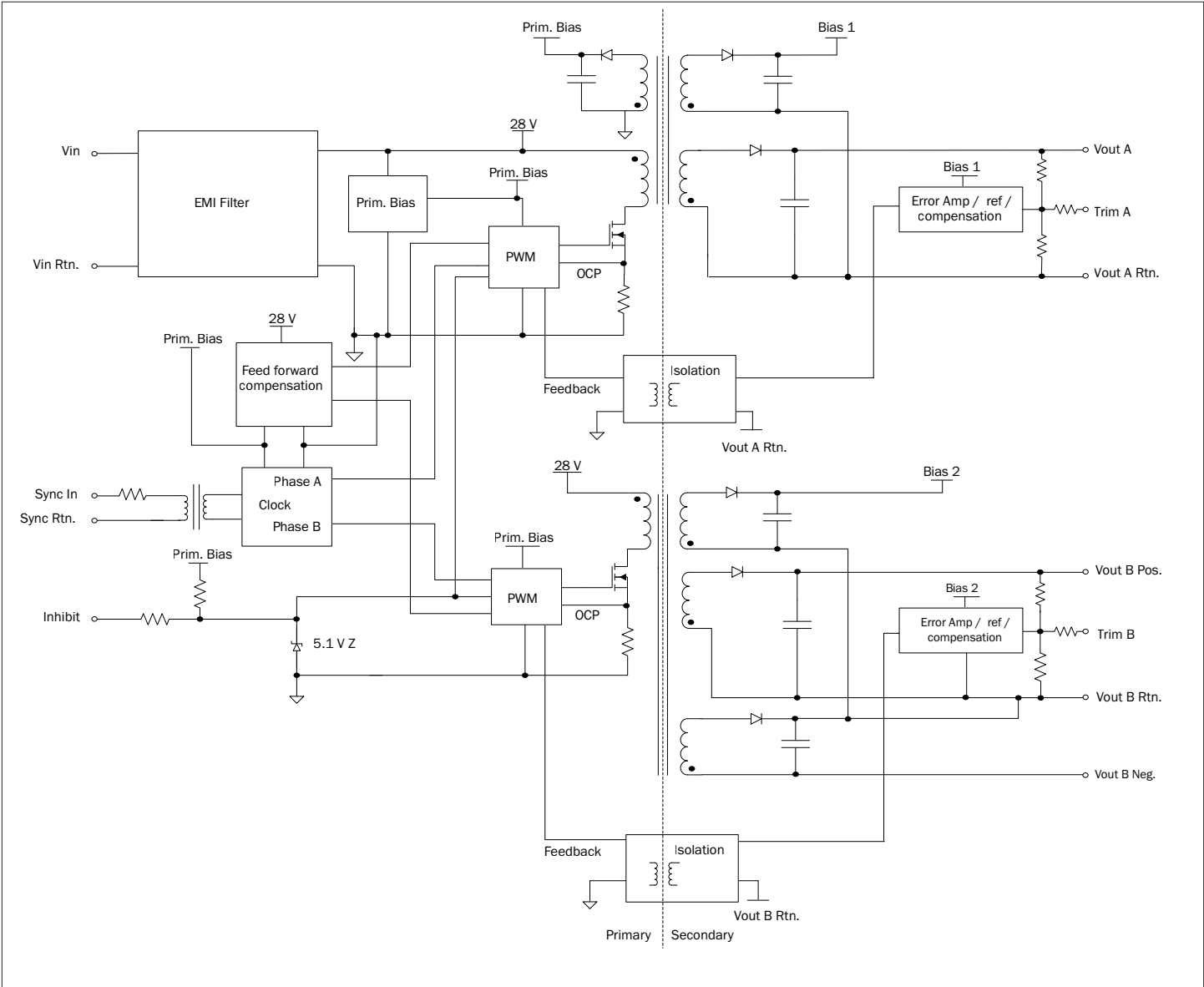

FIGURE 5: SMRT TRIPLE BLOCK DIAGRAM

SMRT Single, Dual and Triple Space DC-DC Converters

19 TO 56 VOLT INPUT – 23 TO 35 WATT – SPACE QUALIFIED

PIN OUT			
Pin	Single Output	Dual Output	Triple Output
1	Vin	Vin	Vin
2	Vin Return	Vin Return	Vin Return
3	Inhibit	Inhibit	Inhibit
4	Sync In	Sync In	Sync In
5	Sync Return	Sync Return	Sync Return
8	Sense	Sense A	Trim B
9	Sense Return	Sense A Return	Vout B Negative
10	Vout A Return ¹	Vout A Return	Vout B Return
11	Vout A ¹	Vout A	Vout B Positive
12	Trim	Trim B	Trim A
13	Vout A ¹	Vout B	Vout A
14	Vout A Return ¹	Vout B Return	Vout A Return

1. To meet specifications for Single Output models, Vout A pins (11 and 13) must be tied together and Vout A Return pins (10 and 14) must be tied together.

CAUTION:
For Triple output models, do not make any connections between TRIM B (pin 8) and V_{OUT} B Negative (pin 9). Any connection between the two can cause the auxiliary voltages to go excessively high and can damage the converter.

TABLE 6: PIN OUT

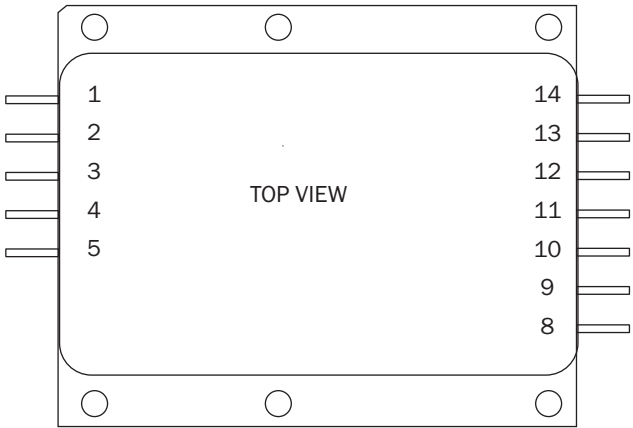

For dimensions see Figure 66 on page 43.

FIGURE 6: PIN OUT

PINS NOT IN USE	
Inhibit	Leave unconnected
Sync In	Connect to Sync Return
Sense Lines (Single and Dual)	Must be connected to appropriate outputs
Trim	Leave unconnected

TABLE 7: PINS NOT IN USE

SMRT Single, Dual and Triple Space DC-DC Converters

19 TO 56 VOLT INPUT – 23 TO 35 WATT – SPACE QUALIFIED

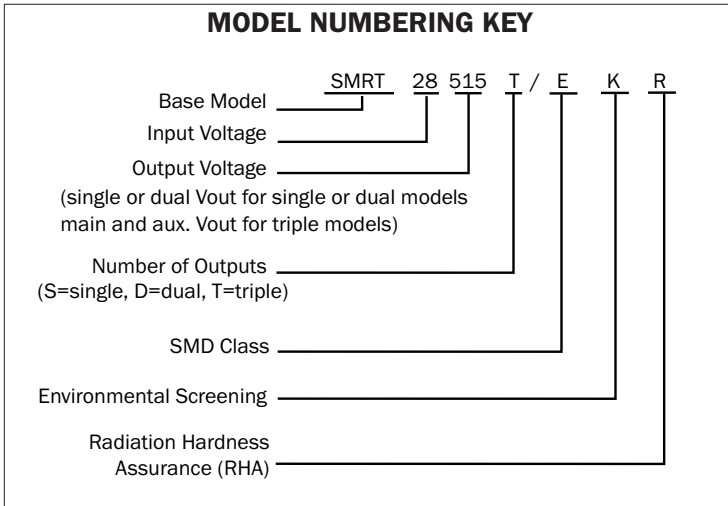

FIGURE 7: MODEL NUMBERING KEY

SMD NUMBERS	
STANDARD MICROCIRCUIT DRAWING (SMD)	SMRT SIMILAR PART
5962R0622001EXC	SMRT283R3S/EKR
5962R0622101EXC	SMRT2805S/EKR
5962R1220101EXC	SMRT288R7S/EKR
5962R0821001EXC	SMRT2812S/EKR
5962R0622201EXC	SMRT2815S/EKR
5962R0622301EXC	SMRT2805D/EKR
5962R0720201EXC	SMRT2812D/EKR
5962R0622401EXC	SMRT2815D/EKR
5962R0821101EXC	SMRT283R312T/EKR
5962R0821201EXC	SMRT283R315T/EKR
5962R1322101EXC	SMRT28507T/EKR
5962R0622501EXC	SMRT28512T/EKR
5962R0622601EXC	SMRT28515T/EKR

The SMD numbers shown are for RHA level R, screening level Class E, standard case (X), standard pin seal and non-solder dipped pins (C). Class E screening is based on Class K requirements of MIL-PRF-38534 with the exception that Constant Acceleration is limited to 3000 g maximum including qualification testing. For other options please refer to the SMD for the SMD number and the vendor similar number. All SMD numbers are listed on the SMD in the "Bulletin" which is the last page of the SMD. For exact specifications for an SMD product, refer to the SMD. SMDs can be downloaded from <https://landandmaritimeapps.dla.mil/programs/smcr>

TABLE 8: SMD NUMBER CROSS REFERENCE

MODEL NUMBER OPTIONS					
TO DETERMINE THE MODEL NUMBER ENTER ONE OPTION FROM EACH CATEGORY IN THE FORM BELOW.					
CATEGORY	Base Model and Input Voltage	Output Voltage ¹	Number of Outputs ^{2, 3}	Screening ⁴	RHA ⁵
OPTIONS	SMRT28	3R3, 05, 8R7, 12, 15	S	O	O
		05, 12, 15	D	EK	P
		3R312, 3R315, 507, 512, 515	T		L
					R
FILL IN FOR MODEL # ⁶	<u>SMRT28</u>	<u> </u>	<u> </u>	<u> </u>	<u> </u>

Notes

- Output Voltage: An R indicates a decimal point. 3R3 is 3.3 volts out. The 3R3 output voltage is only available in single and triple output models. The 3R312 and 3R315 triple output converters are +3.3 volt main and ±12 or ±15 volt auxiliaries. The 507 triple output converter is +5 main and ±7 volt auxiliaries. The 512 and 515 triple output converters are +5 volt main and ±12 or ±15 volt auxiliaries.
- Number of Outputs: S is a single output, D is a dual output, and T is a triple output
- All triple models can be configured as a dual output. See "Triple Output Models Configured as Dual Outputs" on page 3.
- Screening: A screening level of O is a Space Prototype and is only used with RHA O. See Table 27 on page 44 for more information.
- RHA: Interpoint model numbers use an "O" in the RHA designator position to indicate the "-" (dash) RHA level of MIL-PRF-38534, which is defined as "no RHA." RHA O is only available with screening level O. See Table 28 on page 45 for more information.
- If ordering by model number add a "-Q" to request solder dipped leads (SMRT2805S/EKR-Q).

TABLE 9: MODEL NUMBER OPTIONS

SMRT Single, Dual and Triple Space DC-DC Converters

19 TO 56 VOLT INPUT – 23 TO 35 WATT – SPACE QUALIFIED

TABLE 10: OPERATING CONDITIONS - ALL MODELS, 25 ° CASE, 28 VIN, UNLESS OTHERWISE SPECIFIED.

PARAMETER	CONDITIONS	ALL MODELS			UNITS
		MIN	TYP	MAX	
LEAD SOLDERING TEMPERATURE ¹	10 SECONDS MAX.	–	–	300	°C
STORAGE TEMPERATURE ¹		-65	–	+150	°C
CASE OPERATING TEMPERATURE	FULL POWER	-55	–	+125	°C
	ABSOLUTE ¹	-55	–	+135	
DERATING OUTPUT POWER/CURRENT ¹	LINEARLY	From 100% at 125 °C to 0% at 135 °C			
ESD RATING ^{1, 2} MIL-PRF-38534, 3.9.5.8.2	MIL-STD-883 METHOD 3015 CLASS 3B	–	–	≥ 8000	V
ISOLATION: INPUT TO OUTPUT, INPUT TO CASE, OUTPUT TO CASE ³	@ 500 VDC	100	–	–	Megohms
UNDERVOLTAGE LOCKOUT ¹	RISING V _{IN} (TURN ON)	13.07	–	16.37	V
	FALLING V _{IN} (TURN OFF)	12.26	–	15.80	
OUTPUT POWER LIMIT ⁴	% OF FULL LOAD	–	145	–	%
AUDIO REJECTION ¹		–	50	–	dB
SWITCHING FREQUENCY	INPUT FREQUENCY	270	–	330	kHz
SYNCHRONIZATION ⁵	DUTY CYCLE ¹	20	–	80	%
SYNC IS FLOATING AND ISOLATED	ACTIVE LOW	–	–	0.8	V
	ACTIVE HIGH ¹	2.5	–	10	
	REFERENCED TO	SYNC RETURN			
	IF NOT USED	CONNECT TO SYNC RETURN			
INHIBIT ACTIVE LOW (OUTPUT DISABLED)	INHIBIT PIN PULLED LOW ^{1, 6}	–	–	0.4	V
DO NOT APPLY A VOLTAGE TO THE INHIBIT PIN	INHIBIT PIN SOURCE CURRENT ¹	–	–	2	mA
	REFERENCED TO	INPUT COMMON			
INHIBIT ACTIVE HIGH (OUTPUT ENABLED)	INHIBIT PIN CONDITION	OPEN COLLECTOR OR UNCONNECTED			
DO NOT APPLY A VOLTAGE TO THE INHIBIT PIN	OPEN PIN VOLTAGE ¹	5	–	6	V

For mean time between failures (MTBF) contact Applications Engineering at powerapps@craneae.com

Notes

- Guaranteed by characterization test and/or analysis. Not a production test.
- Passes 8000 volts.
- Isolation is tested with the all input pins (referenced to input common) tied together, and all output pins (referenced to output common) tied together. They are tested for isolation input to output, input to case and output to case. Discharge the pins after each test.
- At the output power limit point the output voltage will start to drop as the output current increases in order to limit the output power.
Triple outputs: The over-current limit will trigger when the sum of the auxiliary currents reaches 145% (typical value) of the maximum rated "total" current of the auxiliary outputs.
- If sync is used at lower end of range, full load operation is not guaranteed.
- Tested with Inhibit pin at 0 volts.

SMRT Single, Dual and Triple Space DC-DC Converters

19 TO 56 VOLT INPUT – 23 TO 35 WATT – SPACE QUALIFIED

TABLE 11: ELECTRICAL CHARACTERISTICS: -55°C TO +125°C CASE, 28 VIN, 100% LOAD, UNLESS OTHERWISE SPECIFIED.

SINGLE OUTPUT MODELS		SMRT283R3S			SMRT2805S			SMRT288R7S			UNITS
PARAMETER	CONDITIONS	MIN	TYP	MAX	MIN	TYP	MAX	MIN	TYP	MAX	
OUTPUT VOLTAGE		3.23	3.30	3.37	4.90	5.00	5.10	8.52	8.70	8.87	V
OUTPUT CURRENT		–	–	6.97	–	–	6.0	–	–	4.0	A
OUTPUT POWER		–	–	23	–	–	30	–	–	35	W
OUTPUT RIPPLE	$T_C = 25^\circ\text{C}$	–	–	250	–	–	180	–	–	160	mV p-p
10 kHz - 20 MHz	$T_C = -55^\circ\text{C TO } +125^\circ\text{C}$	–	–	280	–	–	200	–	–	200	
LINE REGULATION ²	$V_{IN} = 19 \text{ TO } 50$	–	5	30	–	5	30	–	5	30	mV
LOAD REGULATION	NL - FL	–	5	40	–	5	40	–	5	40	mV
TOTAL REGULATION ¹ V_{OUT}	ALL CONDITIONS OF LINE, LOAD, AGING, TEMP AND RADIATION	3.0	–	3.6	4.7	–	5.3	8.3	–	9.1	V
INPUT VOLTAGE	CONTINUOUS	19	28	56	19	28	56	19	28	56	V
	TRANSIENT 120 ms ¹	–	–	80	–	–	80	–	–	80	
INPUT CURRENT	NO LOAD	–	–	110	–	–	110	–	–	115	mA
	INHIBITED	–	–	50	–	–	50	–	–	50	
INPUT RIPPLE CURRENT ³	10 kHz - 20 MHz	–	10	50	–	10	50	–	10	50	mA p-p
EFFICIENCY	$T_C = 25^\circ\text{C}$	61	64	–	67	71	–	74	75.5	–	%
	$T_C = -55^\circ\text{C to } +125^\circ\text{C}$	60	–	–	66	–	–	72	–	–	
LOAD FAULT ^{4, 5}	POWER DISSIPATION	–	–	31	–	–	28	–	–	25	W
	RECOVERY ¹	–	–	25	–	–	25	–	–	25	ms
STEP LOAD RESPONSE ^{5, 6, 7} 50% - 100% - 50%	TRANSIENT	–	–	±450	–	–	±450	–	–	±450	mV pk
	RECOVERY	–	–	3	–	–	3	–	–	4	ms
STEP LINE RESPONSE ^{1, 5, 8} $V_{IN} = 19 - 50 - 19$	TRANSIENT	–	–	±500	–	–	±500	–	–	±600	mV pk
	RECOVERY	–	–	4	–	–	4	–	–	4	ms
START-UP ^{5, 9}	DELAY	–	–	35	–	–	25	–	–	25	ms
	OVERSHOOT	–	–	50	–	–	50	–	–	95	mV pk
CAPACITIVE LOAD ^{1, 10}	$T_C = 25^\circ\text{C}$	–	–	5000	–	–	5000	–	–	5000	μF

Notes

1. Guaranteed by characterization test and/or analysis. Not a production test.
2. Line regulation is tested at full load. However, to maintain regulation above 28 volts input, a minimum load is required of 0% at 28 volts input increasing linearly to 5% at 56 volts input.
3. Converters meet MIL-STD-461 specification revisions for conducted emissions C-CE03 and D-/E-/F-CE-102. The actual value of input ripple current is much less, the limit in the characteristic table is based on measurement resolution.
4. Maximum power dissipation when output is shorted.

5. Recovery time is measured from application of the transient to point at which V_{OUT} is within 1% of V_{OUT} at final value.
6. Step load test is performed at 10 microseconds typical.
7. Half load to/from full load.
8. Step line test is performed at 100 microseconds ± 20 microseconds.
9. Measured from release of inhibit or input voltage step.
10. Unconditionally stable, start-up delay increased.

SMRT Single, Dual and Triple Space DC-DC Converters

19 TO 56 VOLT INPUT – 23 TO 35 WATT – SPACE QUALIFIED

TABLE 12: ELECTRICAL CHARACTERISTICS: -55°C TO +125°C CASE, 28 VIN, 100% LOAD, UNLESS OTHERWISE SPECIFIED.

SINGLE OUTPUT MODELS		SMRT2812S			SMRT2815S			UNITS
PARAMETER	CONDITIONS	MIN	TYP	MAX	MIN	TYP	MAX	
OUTPUT VOLTAGE		11.76	12.00	12.24	14.70	15.00	15.30	V
OUTPUT CURRENT		–	–	2.92	0	–	2.33	A
OUTPUT POWER		–	–	35	0	–	35	W
OUTPUT RIPPLE 10 kHz - 20 MHz	T _C = 25°C	–	–	160	–	–	140	mV p-p
	T _C = -55°C TO +125°C	–	–	200	–	–	180	
LINE REGULATION ²	V _{IN} = 19 TO 50	–	5	30	–	5	30	mV
LOAD REGULATION	NL - FL	–	5	40	–	5	40	mV
TOTAL REGULATION ¹ V _{OUT}	ALL CONDITIONS OF LINE, LOAD, AGING, TEMP AND RADIATION	10.9	–	13.1	14.0	–	16.0	V
INPUT VOLTAGE	CONTINUOUS	19	28	56	19	28	56	V
	TRANSIENT 120 ms ¹	–	–	80	–	–	80	
INPUT CURRENT	NO LOAD	–	–	110	–	–	110	mA
	INHIBITED	–	–	50	–	–	50	
INPUT RIPPLE CURRENT ³	10 kHz - 20 MHz	–	10	50	–	10	50	mA p-p
EFFICIENCY	T _C = 25°C	76	78	–	76	80	–	%
	T _C = -55°C TO +125°C	75	–	–	75	–	–	
LOAD FAULT ^{4, 5}	POWER DISSIPATION	–	–	20	–	–	20	W
	RECOVERY ¹	–	–	25	–	–	25	ms
STEP LOAD RESPONSE ^{5, 6, 7} 50% - 100% - 50%	TRANSIENT	–	–	±575	–	–	±575	mV pk
	RECOVERY	–	–	3	–	–	3	ms
STEP LINE RESPONSE ^{1, 5, 8} V _{IN} = 19 - 50 - 19	TRANSIENT	–	–	±700	–	–	±700	mV pk
	RECOVERY	–	–	4	–	–	4	ms
START-UP ^{5, 9}	DELAY	–	–	25	–	–	25	ms
	OVERSHOOT	–	–	120	–	–	150	mV pk
CAPACITIVE LOAD ^{1, 10}	T _C = 25°C	–	–	5000	–	–	5000	µF

Notes

- Guaranteed by characterization test and/or analysis. Not a production test.
- Line regulation is tested at full load. However, to maintain regulation above 28 volts input, a minimum load is required of 0% at 28 volts input increasing linearly to 5% at 56 volts input.
- Converters meet MIL-STD-461 specification revisions for conducted emissions C-CE03 and D-/E-/F-CE-102. The actual value of input ripple current is much less, the limit in the characteristic table is based on measurement resolution.
- Maximum power dissipation when output is shorted.
- Recovery time is measured from application of the transient to point at which V_{OUT} is within 1% of V_{OUT} at final value.
- Step load test is performed at 10 microseconds typical.
- Half load to/from full load.
- Step line test is performed at 100 microseconds ± 20 microseconds.
- Measured from release of inhibit or input voltage step.
- Unconditionally stable, start-up delay increased.

SMRT Single, Dual and Triple Space DC-DC Converters

19 TO 56 VOLT INPUT – 23 TO 35 WATT – SPACE QUALIFIED

TABLE 13: ELECTRICAL CHARACTERISTICS: -55 °C TO +125 °C CASE, 28 VIN, 100% LOAD, UNLESS OTHERWISE SPECIFIED.

DUAL OUTPUT MODELS		SMRT2805D			SMRT2812D			SMRT2815D			UNITS
PARAMETER	CONDITIONS	MIN	TYP	MAX	MIN	TYP	MAX	MIN	TYP	MAX	
OUTPUT VOLTAGE	VOUT A	4.90	5.00	5.10	11.76	12.00	12.24	14.70	15.00	15.30	V
	VOUT B	4.90	5.00	5.10	11.76	12.00	12.24	14.70	15.00	15.30	
OUTPUT CURRENT ²	VOUT A	–	–	3.0	–	–	1.46	–	–	1.17	A
	VOUT B	–	–	3.0	–	–	1.46	–	–	1.17	
OUTPUT POWER ²	VOUT A	–	–	15	–	–	17.5	–	–	17.5	W
	VOUT B	–	–	15	–	–	17.5	–	–	17.5	
OUTPUT RIPPLE 10 kHz - 20 MHz, ± V _{OUT}	T _C = 25 °C	–	–	180	–	–	150	–	–	140	mV p-p
	T _C = -55 °C TO +125 °C	–	–	200	–	–	200	–	–	180	
LINE REGULATION ³	V _{IN} = 19 TO 50	–	–	30	–	5	25	–	5	30	mV
LOAD REGULATION	NL - FL	–	5	40	–	5	50	–	5	40	mV
TOTAL REGULATION ¹ V _{OUT}	ALL CONDITIONS OF LINE, LOAD, AGING, TEMP AND RADIATION	4.6	–	5.4	10.9	–	13.1	14.0	–	16.0	V
INPUT VOLTAGE	CONTINUOUS	19	28	56	19	28	56	19	28	56	V
	TRANSIENT 120 ms ¹	–	–	80	–	–	80	–	–	80	
INPUT CURRENT	NO LOAD	–	–	110	–	–	100	–	–	110	mA
	INHIBITED	–	–	50	–	–	50	–	–	50	
INPUT RIPPLE CURRENT ⁴	10 kHz - 20 MHz	–	10	50	–	10	50	–	10	50	mA p-p
EFFICIENCY	T _C = 25 °C	67	70	–	76	76	–	76	80	–	%
	T _C = -55 °C TO +125 °C	66	–	–	75	–	–	75	–	–	
LOAD FAULT ^{5, 6}	POWER DISSIPATION	–	–	28	–	–	20	–	–	20	W
	RECOVERY ¹	–	–	25	–	–	25	–	–	25	ms
STEP LOAD RESPONSE ^{6, 7, 8} 50% - 100% - 50%	TRANSIENT	–	–	±450	–	–	±450	–	–	±575	mV pk
	RECOVERY	–	–	3	–	–	2	–	–	3	ms
STEP LINE RESPONSE ^{1, 6, 9} V _{IN} = 19 - 50 - 19	TRANSIENT	–	–	±500	–	–	±1000	–	–	±700	mV pk
	RECOVERY	–	–	4	–	–	3	–	–	4	ms
START-UP ^{6, 10}	DELAY	–	–	25	–	–	20	–	–	25	ms
	OVERSHOOT	–	–	50	–	–	350	–	–	150	mV pk
CAPACITIVE LOAD ^{1, 11, 12}	T _C = 25 °C	–	–	5000	–	–	5000	–	–	500	µF

Notes

- Guaranteed by characterization test and/or analysis. Not a production test.
- The specified maximum current/power is available from each output.
- Line regulation is tested at full load. However, to maintain regulation above 28 volts input, a minimum load is required of 0% at 28 volts input increasing linearly to 5% at 56 volts input. Applies to both outputs.
- Converters meet MIL-STD-461 specification revisions for conducted emissions C-CE03 and D-/E-/F-CE-102. The actual value of input ripple current is much less, the limit in the characteristic table is based on measurement resolution.
- Maximum combined power dissipation when both outputs are shorted simultaneously.
- Recovery time is measured from application of the transient to point at which V_{OUT} is within 1% of V_{OUT} at final value.
- Step load test is performed at 10 microseconds typical.
- Half load to/from full load.
- Step line test is performed at 100 microseconds ± 20 microseconds.
- Measured from release of inhibit or input voltage step.
- Applies to each output.
- Unconditionally stable, start-up delay increased.

SMRT Single, Dual and Triple Space DC-DC Converters

19 TO 56 VOLT INPUT – 23 TO 35 WATT – SPACE QUALIFIED

TABLE 14: ELECTRICAL CHARACTERISTICS: -55 °C TO +125 °C CASE, 28 VIN, 100% LOAD, UNLESS OTHERWISE SPECIFIED.

TRIPLE OUTPUT MODEL – SMRT283R312T		3.3 (MAIN)			±12 (AUXILIARIES)			UNITS
PARAMETER	CONDITIONS	MIN	TYP	MAX	MIN	TYP	MAX	
OUTPUT VOLTAGE	MAIN AND POS. AUX	3.23	3.30	3.37	11.76	12.00	12.24	V
	NEG. AUX.	–	–	–	-11.58	-12.00	-12.42	
OUTPUT CURRENT ²	EITHER OUTPUT	–	–	4.5	–	±0.625	1 ¹	A
	MAX TOTAL AUX	–	–	–	–	–	1.25	
OUTPUT POWER ²	EITHER OUTPUT	–	–	15	–	±7.5	12 ¹	W
	MAX TOTAL AUX	–	–	–	–	–	15	
OUTPUT RIPPLE 10 kHz - 20 MHz	T _C = 25 °C	–	–	180	–	–	140	mV p-p
	T _C = -55 °C TO +125 °C	–	–	180	–	–	140	
LINE REGULATION ³ V _{IN} = 19 TO 50	MAIN AND POS. AUX	–	–	30	–	5	30	mV
	NEG. AUX.	–	–	–	–	10	70	
LOAD REGULATION BALANCED AUX.	MAIN & +AUX., NL - FL	–	5	40	–	5	40	mV
	-AUX., NL - FL	–	–	–	–	10	300	
TOTAL REGULATION ¹ V _{OUT}	ALL CONDITIONS OF LINE, LOAD, AGING, TEMP AND RADIATION	3.0	–	3.5	±10.9	–	±13.1	V
INPUT VOLTAGE	CONTINUOUS	19	28	56	–	–	–	V
	TRANSIENT 120 ms ¹	–	–	80	–	–	–	
INPUT CURRENT	NO LOAD	–	–	110	–	–	–	mA
	INHIBITED	–	–	50	–	–	–	
INPUT RIPPLE CURRENT ⁶	10 kHz - 20 MHz	–	10	50	–	–	–	mA p-p
EFFICIENCY ⁷	T _C = 25 °C	69	70.5	–	–	–	–	%
	T _C = -55 °C TO +125 °C	68	–	–	–	–	–	
LOAD FAULT ^{8,9}	POWER DISSIPATION	–	–	28	–	–	28	W
	RECOVERY ¹	–	–	25	–	–	25	ms
STEP LOAD RESPONSE ^{9, 10, 11, 12} 50% - 100% - 50%	TRANSIENT	–	–	±450	–	–	±450	mV pk
	RECOVERY	–	–	3	–	–	3	ms
STEP LINE RESPONSE ^{1, 9, 13} V _{IN} = 19 - 50 - 19	TRANSIENT	–	–	±500	–	–	±750	mV pk
	RECOVERY	–	–	4	–	–	4	ms
START-UP ^{9, 14}	DELAY	–	–	35	–	–	25	ms
	OVERSHOOT	–	0	50	–	0	120	mV pk
CAPACITIVE LOAD ^{1, 15, 16}	T _C = 25 °C	–	–	5000	–	–	1000	µF

See footnotes on page 21

SMRT Single, Dual and Triple Space DC-DC Converters

19 TO 56 VOLT INPUT – 23 TO 35 WATT – SPACE QUALIFIED

TABLE 15: ELECTRICAL CHARACTERISTICS: -55°C TO +125°C CASE, 28 VIN, 100% LOAD, UNLESS OTHERWISE SPECIFIED.

TRIPLE OUTPUT MODEL – SMRT283R312T		3.3 (MAIN)			±12 (AUXILIARIES)			UNITS
PARAMETER	CONDITIONS	MIN	TYP	MAX	MIN	TYP	MAX	
OUTPUT VOLTAGE	MAIN AND POS. AUX	3.23	3.30	3.37	11.76	12.00	12.24	V
	NEG. AUX.	–	–	–	-11.58	-12.00	-12.42	
OUTPUT CURRENT ²	EITHER OUTPUT	–	–	4.5	–	±0.625	1 ¹	A
	MAX TOTAL AUX	–	–	–	–	–	1.25	
OUTPUT POWER ²	EITHER OUTPUT	–	–	15	–	±7.5	12 ¹	W
	MAX TOTAL AUX	–	–	–	–	–	15	
OUTPUT RIPPLE 10 kHz - 20 MHz	T _C = 25°C	–	–	180	–	–	140	mV p-p
	T _C = -55°C TO +125°C	–	–	180	–	–	140	
LINE REGULATION ³ V _{IN} = 19 TO 50	MAIN AND POS. AUX	–	–	30	–	5	30	mV
	NEG. AUX.	–	–	–	–	10	70	
LOAD REGULATION BALANCED AUX.	MAIN & +AUX., NL - FL	–	5	40	–	5	40	mV
	-AUX., NL - FL	–	–	–	–	10	300	
TOTAL REGULATION ¹ V _{OUT}	ALL CONDITIONS OF LINE, LOAD, AGING, TEMP AND RADIATION	3.0	–	3.6	±10.9	–	±13.1	V
CROSS REGULATION ^{1, 4, 5} T _C = 25°C	EFFECT ON NEGATIVE AUXILIARY	–	–	–	–	–	6	%
INPUT VOLTAGE	CONTINUOUS	19	28	56	–	–	–	V
	TRANSIENT 120 ms ¹	–	–	80	–	–	–	
INPUT CURRENT	NO LOAD	–	–	110	–	–	–	mA
	INHIBITED	–	–	50	–	–	–	
INPUT RIPPLE CURRENT ⁶	10 kHz - 20 MHz	–	10	50	–	–	–	mA p-p
EFFICIENCY ⁷	T _C = 25°C	69	70.5	–	–	–	–	%
	T _C = -55°C TO +125°C	68	–	–	–	–	–	
LOAD FAULT ^{8, 9}	POWER DISSIPATION	–	–	28	–	–	28	W
	RECOVERY ¹	–	–	25	–	–	25	ms
STEP LOAD RESPONSE ^{9, 10, 11, 12} 50% - 100% - 50%	TRANSIENT	–	–	±450	–	–	±450	mV pk
	RECOVERY	–	–	3	–	–	3	ms
STEP LINE RESPONSE ^{1, 9, 13} V _{IN} = 19 - 50 - 19	TRANSIENT	–	–	±500	–	–	±750	mV pk
	RECOVERY	–	–	4	–	–	4	ms
START-UP ^{9, 14}	DELAY	–	–	35	–	–	25	ms
	OVERSHOOT	–	0	50	–	0	120	mV pk
CAPACITIVE LOAD ^{1, 15, 16}	T _C = 25°C	–	–	5000	–	–	1000	μF

See footnotes on page 21.

SMRT Single, Dual and Triple Space DC-DC Converters

19 TO 56 VOLT INPUT – 23 TO 35 WATT – SPACE QUALIFIED

TABLE 16: ELECTRICAL CHARACTERISTICS: -55°C TO +125°C CASE, 28 VIN, 100% LOAD, UNLESS OTHERWISE SPECIFIED.

TRIPLE OUTPUT MODEL – SMRT28507T		5 (MAIN)			±7 (AUXILIARIES)			UNITS
PARAMETER	CONDITIONS	MIN	TYP	MAX	MIN	TYP	MAX	
OUTPUT VOLTAGE	MAIN AND POS. AUX	4.90	5.00	5.10	6.86	7.00	7.14	V
	NEG. AUX.				-6.79	7.00	-7.21	
OUTPUT CURRENT ²	MAIN AND EITHER OUTPUT	–	–	3.0	–	±1.00	1.6 ¹	A
	MAX TOTAL AUX	–	–	–	–	–	2.0	
OUTPUT POWER ²	MAIN AND EITHER OUTPUT	–	–	15	–	±7.0	11.2 ¹	W
	MAX TOTAL AUX	–	–	–	–	–	14	
OUTPUT RIPPLE 10 kHz - 20 MHz	T _C = 25°C	–	–	180	–	–	170	mV p-p
	T _C = -55°C TO +125°C	–	–	180	–	–	190	
LINE REGULATION ³ V _{IN} = 19 TO 50	MAIN AND POS. AUX	–	–	30	–	–	100	mV
	NEG. AUX.	–	–	–	–	–	150	
LOAD REGULATION BALANCED AUX.	MAIN AND +AUX., NL - FL	–	5	40	–	5	150	mV
	-AUX., NL - FL	–	–	–	–	–	350	
TOTAL REGULATION ¹ V _{OUT}	EFFECT ON NEGATIVE AUXILIARY AGING, TEMP AND RADIATION	–	–	4	–	–	4	V
CROSS REGULATION ^{1, 4, 5} T _C = 25°C	EFFECT ON NEGATIVE AUXILIARY	–	–	–	–	–	4	%
INPUT VOLTAGE	CONTINUOUS	19	28	56	–	–	–	V
	TRANSIENT 120 ms ¹	–	–	80	–	–	–	
INPUT CURRENT	NO LOAD	–	–	110	–	–	–	mA
	INHIBITED	–	–	50	–	–	–	
INPUT RIPPLE CURRENT ⁶	10 kHz - 20 MHz	–	10	50	–	–	–	mA p-p
EFFICIENCY ⁷	T _C = 25°C	70	71	–	–	–	–	%
	T _C = -55°C TO +125°C	69	–	–	–	–	–	
LOAD FAULT ^{8, 9}	POWER DISSIPATION	–	–	28	–	–	28	W
	RECOVERY ¹	–	–	25	–	–	25	ms
STEP LOAD RESPONSE ^{9, 10, 11, 12} 50% - 100% - 50%	TRANSIENT	–	–	±300	–	–	±400	mV pk
	RECOVERY	–	–	3	–	–	3	ms
STEP LINE RESPONSE ^{1, 9, 13} V _{IN} = 19 - 50 - 19	TRANSIENT	–	–	±500	–	–	±750	mV pk
	RECOVERY	–	–	3	–	–	3	ms
START-UP ^{9, 14}	DELAY	–	–	25	–	–	25	ms
	OVERSHOOT	–	0	50	–	0	70	mV pk
CAPACITIVE LOAD ^{1, 15, 16}	T _C = 25°C	–	–	5000	–	–	1000	μF

See footnotes on page 21.

SMRT Single, Dual and Triple Space DC-DC Converters

19 TO 56 VOLT INPUT – 23 TO 35 WATT – SPACE QUALIFIED

TABLE 17: ELECTRICAL CHARACTERISTICS: -55°C TO +125°C CASE, 28 VIN, 100% LOAD, UNLESS OTHERWISE SPECIFIED.

TRIPLE OUTPUT MODEL – SMRT28512T		5 (MAIN)			±12 (AUXILIARIES)			UNITS
PARAMETER	CONDITIONS	MIN	TYP	MAX	MIN	TYP	MAX	
OUTPUT VOLTAGE	MAIN AND POS. AUX	4.90	5.00	5.10	11.76	12.00	12.24	V
	NEG. AUX.				-11.58	-12.00	-12.42	
OUTPUT CURRENT ²	EITHER OUTPUT	–	–	3.0	–	±0.625	1 ¹	A
	MAX TOTAL AUX	–	–	–	–	–	1.25	
OUTPUT POWER ²	EITHER OUTPUT	–	–	15	–	±7.5	12 ¹	W
	MAX TOTAL AUX	–	–	–	–	–	15	
OUTPUT RIPPLE 10 kHz - 20 MHz	T _C = 25°C	–	–	180	–	–	140	mV p-p
	T _C = -55°C TO +125°C	–	–	200	–	–	150	
LINE REGULATION ³ V _{IN} = 19 TO 50 V	MAIN AND POS. AUX	–	–	30	–	5	30	mV
	NEG. AUX.				–	20	70	
LOAD REGULATION BALANCED AUX.	MAIN & +AUX., NL - FL	–	5	40	–	5	40	mV
	-AUX., NL - FL	–	–	–	–	10	300	
TOTAL REGULATION ¹ V _{OUT}	ALL CONDITIONS OF LINE, LOAD, AGING, TEMP AND RADIATION	4.7	–	5.3	±10.9	–	±13.1	V
CROSS REGULATION ^{1, 4, 5} T _C = 25°C	EFFECT ON NEGATIVE AUXILIARY	–	–	–	–	–	6	%
INPUT VOLTAGE V _{IN} = 19 - 50 - 19	CONTINUOUS	19	28	56	–	–	–	V
	TRANSIENT 120 ms ¹	–	–	80	–	–	–	
INPUT CURRENT	NO LOAD	–	–	110	–	–	–	mA
	INHIBITED	–	–	50	–	–	–	
INPUT RIPPLE CURRENT ⁶	10 kHz - 20 MHz	–	10	50	–	–	–	mA p-p
EFFICIENCY ⁷	T _C = 25°C	69	75	–	–	–	–	%
	T _C = -55°C TO +125°C	68	–	–	–	–	–	
LOAD FAULT ^{8, 9}	POWER DISSIPATION	–	–	25	–	–	25	W
	RECOVERY ¹	–	–	25	–	–	25	ms
STEP LOAD RESPONSE ^{9, 10, 11, 12} 50% - 100% - 50%	TRANSIENT	–	–	±450	–	–	±450	mV pk
	RECOVERY	–	–	3	–	–	3	ms
STEP LINE RESPONSE ^{1, 9, 13} V _{IN} = 19 - 50 - 19	TRANSIENT	–	–	±500	–	–	±750	mV pk
	RECOVERY	–	–	4	–	–	4	ms
START-UP ^{9, 14}	DELAY	–	–	25	–	–	25	ms
	OVERSHOOT	–	0	50	–	0	120	mV pk
CAPACITIVE LOAD ^{1, 15, 16}	T _C = 25°C	–	–	5000	–	–	1000	µF

See footnotes on page 21

SMRT Single, Dual and Triple Space DC-DC Converters

19 TO 56 VOLT INPUT – 23 TO 35 WATT – SPACE QUALIFIED

TABLE 18: ELECTRICAL CHARACTERISTICS: -55 °C TO +125 °C CASE, 28 VIN, 100% LOAD, UNLESS OTHERWISE SPECIFIED.

TRIPLE OUTPUT MODEL – SMRT28515T		5 (MAIN)			±15 (AUXILIARIES)			UNITS
PARAMETER	CONDITIONS	MIN	TYP	MAX	MIN	TYP	MAX	
OUTPUT VOLTAGE	MAIN AND POS. AUX	4.92	5.00	5.08	14.77	15.00	15.23	V
	NEG. AUX.				-14.70	-15.00	-15.30	
OUTPUT CURRENT ²	EITHER OUTPUT	–	–	3.0	–	±0.5	0.80 ¹	A
	MAX TOTAL AUX	–	–	–	–	–	1	
OUTPUT POWER ²	EITHER OUTPUT	–	–	15	–	±7.5	12 ¹	W
	MAX TOTAL AUX	–	–	–	–	–	15	
OUTPUT RIPPLE 10 KHz - 20 MHz	T _C = 25 °C	–	–	180	–	–	150	mV p-p
	T _C = -55 °C TO +125 °C	–	–	200	–	–	200	
LINE REGULATION ³ V _{IN} = 19 TO 50	MAIN AND POS. AUX	–	5	25	–	–	25	mV
	NEG. AUX.				–	20	35	
LOAD REGULATION BALANCED AUX.	MAIN & +AUX., NL - FL	–	5	50	–	5	50	mV
	-AUX., NL - FL	–	–	–	–	–	500	
TOTAL REGULATION ¹ V _{OUT}	ALL CONDITIONS OF LINE, LOAD, AGING, TEMP AND RADIATION	4.7	–	5.3	±10.9	–	±13.1	V
CROSS REGULATION ^{1, 4, 5} T _C = 25 °C	EFFECT ON NEGATIVE AUXILIARY	–	–	–	–	–	6	%
INPUT VOLTAGE	CONTINUOUS	19	28	56	–	–	–	V
	TRANSIENT 120 ms ¹	–	–	80	–	–	–	
INPUT CURRENT	NO LOAD	–	–	110	–	–	–	mA
	INHIBITED	–	–	50	–	–	–	
INPUT RIPPLE CURRENT ⁶	10 KHZ - 20 MHZ	–	10	50	–	–	–	mA p-p
EFFICIENCY ⁷	T _C = 25 °C	72	75	–	–	–	–	%
	T _C = -55 °C TO +125 °C	70	–	–	–	–	–	
LOAD FAULT ^{8, 9}	POWER DISSIPATION	–	–	25	–	–	25	W
	RECOVERY ¹	–	–	35	–	–	35	ms
STEP LOAD RESPONSE ^{9, 10, 11, 12} 50% - 100% - 50%	TRANSIENT	–	–	±250	–	–	±350	mV pk
	RECOVERY	–	–	1	–	–	1	ms
STEP LINE RESPONSE ^{1, 9, 13} V _{IN} = 19 - 50 - 19	TRANSIENT	–	–	±500	–	–	±750	mV pk
	RECOVERY	–	–	1.5	–	–	1.5	ms
START-UP ^{9, 14}	DELAY	–	–	25	–	–	20	ms
	OVERSHOOT	–	0	200	–	0	350	mV pk
CAPACITIVE LOAD ^{1, 15, 16}	T _C = 25 °C	–	–	5000	–	–	1000	µF

See footnotes on page 21

SMRT Single, Dual and Triple Space DC-DC Converters

19 TO 56 VOLT INPUT – 23 TO 35 WATT – SPACE QUALIFIED

ELECTRICAL CHARACTERISTICS: -55 °C TO +125 °C CASE, 28 VIN, 100% LOAD, UNLESS OTHERWISE SPECIFIED.

Notes for triple output models on Table 14 through Table 18.

1. Guaranteed by characterization test and/or analysis. Not a production test.
2. Up to the maximum specified auxiliary output current/power is available from either auxiliary output provided the total auxiliary output current power does not exceed the maximum total current/power specified.
3. Line regulation is tested at full load. However, to maintain regulation above 28 volts input, a minimum load is required of 0% at 28 volts input increasing linearly to 5% at 56 volts in. Load percentage applies to the main output and also to the sum of the auxiliaries.
4. To maintain the cross regulation specification, one of the auxiliaries must always provide a minimum of 20% of the total auxiliary power used. Negative Vout cross regulation is referenced to 50%/50% balanced loads (at 100% of total rated output power - full load).
5. Cross regulation only affects "Vout B Negative" of the auxiliaries and is measured using the following formula:

$$\frac{V_{cond1} - V_{cond2}}{V_{cond1}}$$
 Vcond = "Vout B Negative" under the following loading condition:
 Vcond1: Assumes "Max Total Aux" and a balanced load (50%/50%)
 Vcond2: "Vout B Positive" = 20% of "Max Total Aux" and "Vout B Negative" = 80% of "Max Total Aux"
 OR
 "Vout B Positive" = 80% of "Max Total Aux" and "Vout B Negative" = 20% of "Max Total Aux".
6. Converters meet MIL-STD-461 specification revisions for conducted emissions C-CE03 and D-/E-/F-CE-102. The actual value of input ripple current is much less, the limit in the characteristic table is based on measurement resolution.
7. Efficiency measured with all outputs at full load and is the combined efficiency of all outputs.
8. Maximum power dissipation when the main is shorted with full load on the auxiliaries and when the auxiliaries are shorted with full load on the main. The total power includes the power being used in the not-short-circuit.
9. Recovery time is measured from application of the transient to point at which V_{OUT} is within 1% of V_{OUT} at final value
10. Step load test is performed at 10 microseconds typical.
11. The step load specification for the negative auxiliary output is guaranteed by qualification test. It is not an in-line test.
12. Half load to/from full load.
13. Step line test is performed at 100 microseconds \pm 20 microseconds.
14. Measured from release of inhibit or input voltage step.
15. Applies to each auxiliary.
16. Unconditionally stable, start-up delay increased.

SMRT Single, Dual and Triple Space DC-DC Converters

19 TO 56 VOLT INPUT – 23 TO 35 WATT – SPACE QUALIFIED

TABLE 19: ELECTRICAL CHARACTERISTICS: -55 °C TO +125 °C CASE, 50 VIN, 100% LOAD, UNLESS OTHERWISE SPECIFIED.

SINGLE OUTPUT MODELS		SMRT283R3S			SMRT2805S			SMRT288R7S			UNITS
PARAMETER	CONDITIONS	MIN	TYP	MAX	MIN	TYP	MAX	MIN	TYP	MAX	
OUTPUT VOLTAGE ²		3.23	3.30	3.37	4.90	5.00	5.10	8.52	8.70	8.87	V
OUTPUT CURRENT ²		0.28	–	6.97	0.24	–	6.0	0.16	–	4.0	A
OUTPUT POWER		0.92	–	23	1.2	–	30	1.4	–	35	W
OUTPUT RIPPLE	T _C = 25 °C	–	–	250	–	–	200	–	–	200	mV p-p
10 kHz - 20 MHz	T _C = -55 °C TO +125 °C	–	–	280	–	–	200	–	–	200	
LINE REGULATION ²	V _{IN} = 19 TO 50	–	–	30	–	–	30	–	–	30	mV
	V _{IN} = 19 TO 56	–	–	60	–	–	60	–	–	30	
LOAD REGULATION	5% - FL	–	–	80	–	–	70	–	–	80	mV
TOTAL REGULATION ¹ V _{OUT}	ALL CONDITIONS OF LINE, LOAD, AGING, TEMP AND RADIATION	3.0	–	3.6	4.7	–	5.3	8.3	–	9.1	V
INPUT VOLTAGE	CONTINUOUS	19	50	56	19	50	56	19	50	56	V
	TRANSIENT ¹ 120 ms	–	–	80	–	–	80	–	–	80	
INPUT CURRENT	NO LOAD	–	–	100	–	–	100	–	–	105	mA
	INHIBITED	–	–	55	–	–	55	–	–	55	
INPUT RIPPLE CURRENT ³	10 kHz - 20 MHz	–	–	60	–	–	60	–	–	60	mA p-p
EFFICIENCY	T _C = 25 °C	60	–	–	66	–	–	72	–	–	%
	T _C = -55 °C TO +125 °C	60	–	–	66	–	–	72	–	–	
STEP LOAD RESPONSE ^{4, 5, 6} 50% - 100% - 50%	TRANSIENT	–	–	±450	–	–	±450	–	–	±450	mV pk
	RECOVERY	–	–	3	–	–	3	–	–	4	ms
STEP LINE RESPONSE ^{1, 4, 7} V _{IN} = 19 - 50 - 19	TRANSIENT	–	–	±500	–	–	±500	–	–	±600	mV pk
	RECOVERY	–	–	4	–	–	4	–	–	4	ms
START-UP ^{4, 8}	DELAY	–	–	35	–	–	25	–	–	25	ms
	OVERSHOOT	–	–	50	–	–	50	–	–	95	mV pk
CAPACITIVE LOAD ^{1, 9}	T _C = 25 °C	–	–	5000	–	–	5000	–	–	5000	µF

Notes

- Guaranteed by characterization test and/or analysis. Not a production test.
- Line regulation is tested at full load. However, to maintain regulation above 28 volts input, a minimum load is required of 0% at 28 volts input increasing linearly to 5% at 56 volts input.
- Converters meet MIL-STD-461 specification revisions for conducted emissions C-CE03 and D-/E-/F-CE-102. The actual value of input ripple current is much less, the limit in the characteristic table is based on measurement resolution.
- Recovery time is measured from application of the transient to point at which V_{OUT} is within 1% of V_{OUT} at final value.
- Step load test is performed at 10 microseconds typical.
- Half load to/from full load.
- Step line test is performed at 100 microseconds ± 20 microseconds.
- Measured from release of inhibit or input voltage step.
- Unconditionally stable, start-up delay increased.

SMRT Single, Dual and Triple Space DC-DC Converters

19 TO 56 VOLT INPUT – 23 TO 35 WATT – SPACE QUALIFIED

TABLE 20: ELECTRICAL CHARACTERISTICS: -55 °C TO +125 °C CASE, 50 VIN, 100% LOAD, UNLESS OTHERWISE SPECIFIED.

SINGLE OUTPUT MODELS		SMRT2812S			SMRT2815S			UNITS
PARAMETER	CONDITIONS	MIN	TYP	MAX	MIN	TYP	MAX	
OUTPUT VOLTAGE		11.76	12.00	12.24	14.70	15.00	15.30	V
OUTPUT CURRENT ²		0.116	–	2.92	0.093	–	2.33	A
OUTPUT POWER ²		1.4	–	35	1.4	–	35	W
OUTPUT RIPPLE	T _C = 25 °C	–	–	200	–	–	180	mV p-p
10 kHz - 20 MHz	T _C = -55 °C TO +125 °C	–	–	200	–	–	180	
LINE REGULATION ²	V _{IN} = 19 TO 50	–	–	25	–	–	30	mV
	V _{IN} = 19 TO 56	–	–	50	–	–	60	
LOAD REGULATION	5% - FL	–	–	70	–	–	90	mV
TOTAL REGULATION ¹	ALL CONDITIONS OF LINE, LOAD, AGING, TEMP AND RADIATION	10.9	–	13.1	14.0	–	16.0	V
V _{OUT}								
INPUT VOLTAGE	CONTINUOUS	19	50	56	19	50	56	V
	TRANSIENT ¹ 120 ms	–	–	80	–	–	80	
INPUT CURRENT	NO LOAD	–	–	100	–	–	100	mA
	INHIBITED	–	–	55	–	–	55	
INPUT RIPPLE CURRENT ³	10 kHz - 20 MHz	–	–	60	–	–	60	mA p-p
EFFICIENCY	T _C = 25 °C	72	–	–	72	–	–	%
	T _C = -55 °C TO +125 °C	72	–	–	72	–	–	
STEP LOAD RESPONSE ^{4, 5, 6}	TRANSIENT	–	–	±575	–	–	±575	mV pk
50% - 100% - 50%	RECOVERY	–	–	3	–	–	3	ms
STEP LINE RESPONSE ^{1, 4, 7}	V _{IN} TRANSIENT	–	–	±700	–	–	±700	mV pk
V _{IN} = 19 - 50 - 19	RECOVERY	–	–	4	–	–	4	ms
START-UP ^{4, 8}	DELAY	–	–	25	–	–	25	ms
	OVERSHOOT	–	–	120	–	–	150	mV pk
CAPACITIVE LOAD ^{1, 9}	T _C = 25 °C	–	–	5000	–	–	5000	µF

Notes

- Guaranteed by characterization test and/or analysis. Not a production test.
- Line regulation is tested at full load. However, to maintain regulation above 28 volts input, a minimum load is required of 0% at 28 volts input increasing linearly to 5% at 56 volts input.
- Converters meet MIL-STD-461 specification revisions for conducted emissions C-CE03 and D-/E-/F-CE-102. The actual value of input ripple current is much less, the limit in the characteristic table is based on measurement resolution.
- Recovery time is measured from application of the transient to point at which V_{OUT} is within 1% of V_{OUT} at final value.
- Step load test is performed at 10 microseconds typical.
- Half load to/from full load.
- Step line test is performed at 100 microseconds ± 20 microseconds.
- Measured from release of inhibit or input voltage step.
- Unconditionally stable, start-up delay increased.

SMRT Single, Dual and Triple Space DC-DC Converters

19 TO 56 VOLT INPUT – 23 TO 35 WATT – SPACE QUALIFIED

TABLE 21: ELECTRICAL CHARACTERISTICS: -55°C TO +125°C CASE, 50 VIN, 100% LOAD, UNLESS OTHERWISE SPECIFIED.

DUAL OUTPUT MODELS		SMRT2805D			SMRT2812D			SMRT2815D			UNITS
PARAMETER	CONDITIONS	MIN	TYP	MAX	MIN	TYP	MAX	MIN	TYP	MAX	
OUTPUT VOLTAGE	VOUT A	4.90	5.00	5.10	11.76	12.00	12.24	14.70	15.00	15.30	V
	VOUT B	4.90	5.00	5.10	11.76	12.00	12.24	14.70	15.00	15.30	
OUTPUT CURRENT ^{2, 3}	VOUT A	0.12	–	3.0	0.06	–	1.46	0.05	–	1.17	A
	VOUT B	0.12	–	3.0	0.06	–	1.46	0.05	–	1.17	
OUTPUT POWER ^{2, 3}	VOUT A	0.60	–	15	0.70	–	17.5	0.70	–	17.5	W
	VOUT B	0.60	–	15	0.70	–	17.5	0.70	–	17.5	
OUTPUT RIPPLE 10 kHz - 20 MHz ± VOUT	T _C = 25°C	–	–	200	–	–	170	–	–	180	mV p-p
	TC = -55°C TO +125°C	–	–	200	–	–	200	–	–	180	
LINE REGULATION ³	V _{IN} = 19 TO 50	–	–	30	–	–	25	–	–	30	mV
	V _{IN} = 19 TO 56	–	–	60	–	–	25	–	–	60	
LOAD REGULATION	50 V _{IN} , 5% - FL	–	–	70	–	–	100	–	–	70	mV
TOTAL REGULATION ¹ V _{OUT}	ALL CONDITIONS OF LINE, LOAD, AGING, TEMP AND RADIATION	4.6	–	5.4	10.9	–	13.1	14.0	–	16.0	V
INPUT VOLTAGE	CONTINUOUS	19	50	56	19	50	56	19	50	56	V
	TRANSIENT 120 ms	–	–	80	–	–	80	–	–	80	
INPUT CURRENT	NO LOAD	–	–	100	–	–	100	–	–	100	mA
	INHIBITED	–	–	55	–	–	55	–	–	55	
INPUT RIPPLE CURRENT ⁴	10 kHz - 20 MHz	–	–	60	–	–	60	–	–	60	mA p-p
EFFICIENCY	T _C = 25°C	66	–	–	72	–	–	72	–	–	%
	TC = -55°C TO +125°C	66	–	–	72	–	–	70	–	–	
STEP LOAD RESPONSE ^{5, 6, 7} 50% - 100% - 50%	TRANSIENT	–	–	±450	–	–	±450	–	–	±575	mV pk
	RECOVERY	–	–	3	–	–	2	–	–	3	ms
STEP LINE RESPONSE ^{1, 5, 8} V _{IN} = 19 - 50 - 19	TRANSIENT	–	–	±500	–	–	±1000	–	–	±700	mV pk
	RECOVERY	–	–	4	–	–	3	–	–	4	ms
START-UP ^{5, 9}	DELAY	–	–	25	–	–	20	–	–	25	ms
	OVERSHOOT	–	–	50	–	–	350	–	–	150	mV pk
CAPACITIVE LOAD ^{1, 10, 11}	T _C = 25°C	–	–	5000	–	–	5000	–	–	5000	µF

Notes

- Guaranteed by characterization test and/or analysis. Not a production test.
- The specified maximum current/power is available from each output.
- Line regulation is tested at full load. However, to maintain regulation above 28 volts input, a minimum load is required of 0% at 28 volts input increasing linearly to 5% at 56 volts input. Applies to both outputs.
- Converters meet MIL-STD-461 specification revisions for conducted emissions C-CE03 and D-/E-/F-CE-102. The actual value of input ripple current is much less, the limit in the characteristic table is based on measurement resolution.
- Recovery time is measured from application of the transient to point at which V_{OUT} is within 1% of V_{OUT} at final value.
- Step load test is performed at 10 microseconds typical.
- Half load to/from full load.
- Step line test is performed at 100 microseconds ± 20 microseconds.
- Measured from release of inhibit or input voltage step.
- Applies to each output.
- Unconditionally stable, start-up delay increased.

SMRT Single, Dual and Triple Space DC-DC Converters

19 TO 56 VOLT INPUT – 23 TO 35 WATT – SPACE QUALIFIED

TABLE 22: ELECTRICAL CHARACTERISTICS: -55 °C TO +125 °C CASE, 50 VIN, 100% LOAD, UNLESS OTHERWISE SPECIFIED.

TRIPLE OUTPUT MODEL – SMRT283R312T		3.3 (MAIN)			±12 (AUXILIARIES)			UNITS
PARAMETER	CONDITIONS	MIN	TYP	MAX	MIN	TYP	MAX	
OUTPUT VOLTAGE	MAIN AND POS. AUX	3.23	3.30	3.37	11.76	12.00	12.24	V
	NEG. AUX.	–	–	–	-11.58	-12.00	-12.42	
OUTPUT CURRENT ^{2, 3}		0.18	–	4.5	±0.04	±0.63	1 ¹	A
	MAX TOTAL AUX.	–	–	–	–	–	1.25	
OUTPUT POWER ^{2, 3}		0.60	–	15	0.48	±7.5	12 ¹	W
	MAX TOTAL AUX	–	–	–	–	–	15	
OUTPUT RIPPLE 10 kHz - 20 MHz	T _C = 25 °C	–	–	200	–	–	150	mV p-p
	T _C = -55 °C TO +125 °C	–	–	200	–	–	150	
LINE REGULATION ³ V _{IN} = 19 TO 50	MAIN AND POS. AUX	–	–	30	–	–	30	mV
	NEG. AUX.	–	–	–	–	–	70	
LINE REGULATION ³ V _{IN} = 19 TO 56	MAIN AND POS. AUX	–	–	60	–	–	60	mV
	NEG. AUX.	–	–	–	–	–	140	
LOAD REGULATION BALANCED AUX.	MAIN & +AUX., 5% - FL	–	–	100	–	–	120	mV
	-AUX., 5% - FL	–	–	–	–	–	300	
TOTAL REGULATION ¹ V _{OUT}	ALL CONDITIONS OF LINE, LOAD, AGING, TEMP AND RADIATION	3.0	–	3.6	±10.9	–	±13.1	V
CROSS REGULATION ^{1, 4, 5} T _C = 25 °C	EFFECT ON NEGATIVE AUXILIARY	–	–	–	–	–	6	%
INPUT VOLTAGE	CONTINUOUS	19	50	56	–	–	–	V
	TRANSIENT 120 ms ¹	–	–	80	–	–	–	
INPUT CURRENT	NO LOAD	–	–	100	–	–	–	mA
	INHIBITED	–	–	55	–	–	–	
INPUT RIPPLE CURRENT ⁶	10 kHz - 20 MHz	–	–	60	–	–	–	mA p-p
EFFICIENCY ⁷	T _C = 25 °C	67	–	–	–	–	–	%
	T _C = -55 °C TO +125 °C	67	–	–	–	–	–	
STEP LOAD RESPONSE ^{8, 9, 10, 11} 50% - 100% - 50%	TRANSIENT	–	–	±450	–	–	±450	mV pk
	RECOVERY	–	–	3	–	–	3	ms
STEP LINE RESPONSE ^{1, 8, 12} V _{IN} = 19 - 50 - 19	TRANSIENT	–	–	±500	–	–	±750	mV pk
	RECOVERY	–	–	4	–	–	4	ms
START-UP ^{8, 13}	DELAY	–	–	35	–	–	25	ms
	OVERSHOOT	–	–	50	–	–	120	mV pk
CAPACITIVE LOAD ^{1, 14, 15}	T _C = 25 °C	–	–	5000	–	–	1000	µF

See footnotes on page 30

SMRT Single, Dual and Triple Space DC-DC Converters

19 TO 56 VOLT INPUT – 23 TO 35 WATT – SPACE QUALIFIED

TABLE 23: ELECTRICAL CHARACTERISTICS: -55 °C TO +125 °C CASE, 50 VIN, 100% LOAD, UNLESS OTHERWISE SPECIFIED.

TRIPLE OUTPUT MODEL – SMRT283R315T		3.3 (MAIN)			±15 (AUXILIARIES)			UNITS
PARAMETER	CONDITIONS	MIN	TYP	MAX	MIN	TYP	MAX	
OUTPUT VOLTAGE	MAIN AND POS. AUX	3.23	3.30	3.37	14.70	15.00	15.30	V
	NEG. AUX.				-14.48	-15.00	-15.53	
OUTPUT CURRENT ^{2, 3}		0.18	–	4.5	±0.02	±0.5	0.8 ¹	A
	MAX TOTAL AUX.	–	–	–	–	–	1.0	
OUTPUT POWER ^{2, 3}		0.06	–	15	0.48	±7.5	12 ¹	W
	MAX TOTAL AUX	–	–	–	–	–	15	
OUTPUT RIPPLE 10 kHz - 20 MHz	T _C = 25 °C	–	–	200	–	–	150	mV p-p
	T _C = -55 °C TO +125 °C	–	–	200	–	–	150	
LINE REGULATION ³ V _{IN} = 19 TO 50	MAIN AND POS. AUX	–	–	30	–	–	30	mV
	NEG. AUX.	–	–	–	–	–	70	
LINE REGULATION ³ V _{IN} = 19 TO 56	MAIN AND POS. AUX	–	–	60	–	–	60	mV
	NEG. AUX.	–	–	–	–	–	140	
LOAD REGULATION BALANCED AUX.	MAIN & +AUX., 5% - FL	–	–	100	–	–	120	mV
	-AUX., 5% - FL	–	–	–	–	–	300	
TOTAL REGULATION ¹ V _{OUT}	ALL CONDITIONS OF LINE, LOAD, AGING, TEMP AND RADIATION	3.0	–	3.6	±14.0	–	±16.0	V
CROSS REGULATION ^{1, 4, 5} T _C = 25 °C	EFFECT ON NEGATIVE AUXILIARY	–	–	–	–	–	4	%
INPUT VOLTAGE	CONTINUOUS	19	50	56	–	–	–	V
	TRANSIENT 120 ms ¹	–	–	80	–	–	–	
INPUT CURRENT	NO LOAD	–	–	95	–	–	–	mA
	INHIBITED	–	–	55	–	–	–	
INPUT RIPPLE CURRENT ⁶	10 kHz - 20 MHz	–	–	60	–	–	–	mA p-p
EFFICIENCY ⁷	T _C = 25 °C	68	–	–	–	–	–	%
	T _C = -55 °C TO +125 °C	68	–	–	–	–	–	
STEP LOAD RESPONSE ^{8, 9, 10, 11} 50% - 100% - 50%	TRANSIENT	–	–	±350	–	–	±350	mV pk
	RECOVERY	–	–	2.5	–	–	2.5	ms
STEP LINE RESPONSE ^{1, 8, 12}	TRANSIENT	–	–	±500	–	–	±750	mV pk
	RECOVERY	–	–	4	–	–	4	ms
START-UP ^{8, 13} V _{IN} = 19 - 50 - 19	DELAY	–	–	35	–	–	25	ms
	OVERSHOOT	–	–	50	–	–	150	mV pk
CAPACITIVE LOAD ^{1, 14, 15}	T _C = 25 °C		–	5000	–	–	1000	µF

See footnotes on page 30

SMRT Single, Dual and Triple Space DC-DC Converters

19 TO 56 VOLT INPUT – 23 TO 35 WATT – SPACE QUALIFIED

TABLE 24: ELECTRICAL CHARACTERISTICS: -55 °C TO +125 °C CASE, 50 VIN, 100% LOAD, UNLESS OTHERWISE SPECIFIED.

TRIPLE OUTPUT MODEL – SMRT28507T		5 (MAIN)			±7 (AUXILIARIES)			UNITS
PARAMETER	CONDITIONS	MIN	TYP	MAX	MIN	TYP	MAX	
OUTPUT VOLTAGE	MAIN AND POS. AUX	4.90	5.00	5.10	6.86	7.00	7.14	V
	NEG. AUX.				-6.79	7.00	-7.21	
OUTPUT CURRENT ^{2, 3}		0.12	–	3.0	±0.04	±1.00	1.6 ¹	A
	MAX TOTAL AUX.	–	–	–	–	–	2.0	
OUTPUT POWER ^{2, 3}		0.60	–	15	0.28	±7.0	11.2 ¹	W
	MAX TOTAL AUX	–	–	–	–	–	14	
OUTPUT RIPPLE 10 kHz - 20 MHz	T _C = 25 °C	–	–	230	–	–	200	mV p-p
	T _C = -55 °C TO +125 °C	–	–	230	–	–	200	
LINE REGULATION ³ V _{IN} = 19 TO 50	MAIN AND POS. AUX	–	–	30	–	–	100	mV
	NEG. AUX.	–	–	–	–	–	150	
LINE REGULATION ³ V _{IN} = 19 TO 56	MAIN AND POS. AUX	–	–	30	–	–	100	mV
	NEG. AUX.	–	–	–	–	–	150	
LOAD REGULATION BALANCED AUX.	MAIN & +AUX., 5% - FL	–	–	100	–	–	120	mV
	-AUX., 5% - FL	–	–	–	–	–	300	
TOTAL REGULATION ¹ V _{OUT}	ALL CONDITIONS OF LINE, LOAD, AGING, TEMP AND RADIATION	4.7	–	5.3	±6.53	–	±7.47	V
CROSS REGULATION ^{1, 4, 5} T _C = 25 °C	EFFECT ON NEGATIVE AUXILIARY	–	–	–	–	–	9	%
INPUT VOLTAGE	CONTINUOUS	19	50	56	–	–	–	V
	TRANSIENT 120 ms ¹	–	–	80	–	–	–	
INPUT CURRENT	NO LOAD	–	–	95	–	–	–	mA
	INHIBITED	–	–	55	–	–	–	
INPUT RIPPLE CURRENT ⁶	10 kHz - 20 MHz	–	–	60	–	–	–	mA p-p
EFFICIENCY ⁷	T _C = 25 °C	68	–	–	–	–	–	%
	T _C = -55 °C TO +125 °C	68	–	–	–	–	–	
STEP LOAD RESPONSE ^{8, 9, 10, 11} 50% - 100% - 50%	TRANSIENT	–	–	±300	–	–	±400	mV pk
	RECOVERY	–	–	2	–	–	2	ms
STEP LINE RESPONSE ^{1, 8, 12} V _{IN} = 19 - 50 - 19	TRANSIENT	–	–	±500	–	–	±750	mV pk
	RECOVERY	–	–	4	–	–	4	ms
START-UP ^{8, 13}	DELAY	–	–	20	–	–	20	ms
	OVERSHOOT	–	–	50	–	–	70	mV pk
CAPACITIVE LOAD ^{1, 14, 15}	T _C = 25 °C		–	5000	–	–	1000	μF

See footnotes on page 30

SMRT Single, Dual and Triple Space DC-DC Converters

19 TO 56 VOLT INPUT – 23 TO 35 WATT – SPACE QUALIFIED

TABLE 25: ELECTRICAL CHARACTERISTICS: -55 °C TO +125 °C CASE, 50 VIN, 100% LOAD, UNLESS OTHERWISE SPECIFIED.

TRIPLE OUTPUT MODEL – SMRT28512T		5 (MAIN)			±12 (AUXILIARIES)			UNITS
PARAMETER	CONDITIONS	MIN	TYP	MAX	MIN	TYP	MAX	
OUTPUT VOLTAGE	MAIN AND POS. AUX	4.90	5.00	5.10	11.76	12.00	12.24	V
	NEG. AUX.				-11.58	-12.00	-12.42	
OUTPUT CURRENT ^{2, 3}		0.12	–	3.0	±0.03	±0.63	1 ¹	A
	MAX TOTAL AUX	–	–	–	–	–	1.25	
OUTPUT POWER ^{2, 3}		0.60	–	15	0.48	±7.5	12 ¹	W
	MAX TOTAL AUX	–	–	–	–	–	15	
OUTPUT RIPPLE 10 kHz - 20 MHz	T _C = 25 °C	–	–	200	–	–	150	mV p-p
	T _C = -55 °C TO +125 °C	–	–	200	–	–	150	
LINE REGULATION ³ V _{IN} = 19 TO 50	MAIN AND POS. AUX	–	–	30	–	–	30	mV
	NEG. AUX.	–	–	–	–	–	70	
LINE REGULATION ³ V _{IN} = 19 TO 56	MAIN AND POS. AUX	–	–	60	–	–	60	mV
	NEG. AUX.	–	–	–	–	–	140	
LOAD REGULATION BALANCED AUX.	MAIN & +AUX., 5% - FL	–	–	100	–	–	120	mV
	-AUX., 5% - FL	–	–	–	–	–	300	
TOTAL REGULATION ¹ V _{OUT}	ALL CONDITIONS OF LINE, LOAD, AGING, TEMP AND RADIATION	4.7	–	5.3	±10.9	–	±13.1	V
CROSS REGULATION ^{1, 4, 5} T _C = 25 °C	EFFECT ON NEGATIVE AUXILIARY	–	–	–	–	–	6	%
INPUT VOLTAGE	CONTINUOUS	19	50	56	–	–	–	V
	TRANSIENT 120 ms ¹	–	–	80	–	–	–	
INPUT CURRENT	NO LOAD	–	–	100	–	–	–	mA
	INHIBITED	–	–	55	–	–	–	
INPUT RIPPLE CURRENT ⁶	10 kHz - 20 MHz	–	–	60	–	–	–	mA p-p
EFFICIENCY ⁷	T _C = 25 °C	70	–	–	–	–	–	%
	T _C = -55 °C TO +125 °C	70	–	–	–	–	–	
STEP LOAD RESPONSE ^{8, 9, 10, 11} 50% - 100% - 50%	TRANSIENT	–	–	±350	–	–	±350	mV pk
	RECOVERY	–	–	2.5	–	–	2.5	ms
STEP LINE RESPONSE ^{1, 8, 12} V _{IN} = 19 - 50 - 19	TRANSIENT	–	–	±500	–	–	±750	mV pk
	RECOVERY	–	–	4	–	–	4	ms
START-UP ^{8, 13}	DELAY	–	–	20	–	–	20	ms
	OVERSHOOT	–	–	50	–	–	120	mV pk
CAPACITIVE LOAD ^{1, 14, 15}	T _C = 25 °C		–	5000	–	–	1000	µF

See footnotes on page 30

SMRT Single, Dual and Triple Space DC-DC Converters

19 TO 56 VOLT INPUT – 23 TO 35 WATT – SPACE QUALIFIED

TABLE 26: ELECTRICAL CHARACTERISTICS: -55 °C TO +125 °C CASE, 50 VIN, 100% LOAD, UNLESS OTHERWISE SPECIFIED.

TRIPLE OUTPUT MODEL – SMRT28515T		5 (MAIN)			±15 (AUXILIARIES)			UNITS
PARAMETER	CONDITIONS	MIN	TYP	MAX	MIN	TYP	MAX	
OUTPUT VOLTAGE	MAIN AND POS. AUX	4.92	5.00	5.08	14.77	15.00	15.23	V
	NEG. AUX.				-14.70	-15.00	-15.30	
OUTPUT CURRENT ^{2, 3}		0.12	–	3.0	±0.02	±0.5	0.80 ¹	A
	MAX TOTAL AUX.	–	–	–	–	–	1	
OUTPUT POWER ^{2, 3}		0.60	–	15	0.30	±7.5	12 ¹	W
	MAX TOTAL AUX	–	–	–	–	–	15	
OUTPUT RIPPLE 10 kHz - 20 MHz	T _C = 25 °C	–	–	200	–	–	200	mV p-p
	T _C = -55 °C TO +125 °C	–	–	200	–	–	200	
LINE REGULATION ³ V _{IN} = 19 TO 50	MAIN AND POS. AUX	–	–	25	–	–	25	mV
	NEG. AUX.	–	–	–	–	–	35	
LINE REGULATION ³ V _{IN} = 19 TO 56	MAIN AND POS. AUX	–	–	50	–	–	50	mV
	NEG. AUX.	–	–	–	–	–	70	
LOAD REGULATION BALANCED AUX.	MAIN & +AUX., 5% - FL	–	–	100	–	–	120	mV
	-AUX., 5% - FL	–	–	–	–	–	300	
TOTAL REGULATION ¹ V _{OUT}	ALL CONDITIONS OF LINE, LOAD, AGING, TEMP AND RADIATION	4.7	–	5.3	±14.0	–	±16.0	V
CROSS REGULATION ^{1, 4, 5} T _C = 25 °C	EFFECT ON NEGATIVE AUXILIARY	–	–	–	–	–	4	%
INPUT VOLTAGE	CONTINUOUS	19	50	56	–	–	–	V
	TRANSIENT 120 ms ¹	–	–	80	–	–	–	
INPUT CURRENT	NO LOAD	–	–	100	–	–	–	mA
	INHIBITED	–	–	55	–	–	–	
INPUT RIPPLE CURRENT ⁶	10 kHz - 20 MHz	–	–	50	–	–	–	mA p-p
EFFICIENCY ⁷	T _C = 25 °C	70	–	–	–	–	–	%
	T _C = -55 °C TO +125 °C	70	–	–	–	–	–	
STEP LOAD RESPONSE ^{8, 9, 10, 11} 50% - 100% - 50%	TRANSIENT	–	–	±250	–	–	±350	mV pk
	RECOVERY	–	–	1	–	–	1	ms
STEP LINE RESPONSE ^{1, 8, 12} V _{IN} = 19 - 50 - 19	TRANSIENT	–	–	±500	–	–	±750	mV pk
	RECOVERY	–	–	1.5	–	–	1.5	ms
START-UP ^{8, 13}	DELAY	–	–	25	–	–	20	ms
	OVERSHOOT	–	–	200	–	–	350	mV pk
CAPACITIVE LOAD ^{1, 14, 15}	T _C = 25 °C		–	5000	–	–	1000	μF

See footnotes on page 30

SMRT Single, Dual and Triple Space DC-DC Converters

19 TO 56 VOLT INPUT – 23 TO 35 WATT – SPACE QUALIFIED

Electrical Characteristics: -55°C to +125°C case, 50 Vin, 100% load, unless otherwise specified.

Notes for triple output models on Table 22 through Table 26.

1. Guaranteed by characterization test and/or analysis. Not a production test.
2. Up to the maximum specified auxiliary output current/power is available from either auxiliary output provided the total auxiliary output current power does not exceed the maximum total current/power specified.
3. Line regulation is tested at full load. However, to maintain regulation above 28 volts input, a minimum load is required of 0% at 28 volts input increasing linearly to 5% at 56 volts in. Load percentage applies to the main output and also to the sum of the auxiliaries.
4. To maintain the cross regulation specification, one of the auxiliaries must always provide a minimum of 20% of the total auxiliary power used. Negative Vout cross regulation is referenced to 50%/50% balanced loads (at 100% of total rated output power - full load).
5. Cross regulation only affects "Vout B Negative" of the auxiliaries and is measured using the following formula:

$$\frac{V_{cond1} - V_{cond2}}{V_{cond1}}$$
 Vcond = "Vout B Negative" under the following loading condition:
 Vcond1: Assumes "Max Total Aux" and a balanced load (50%/50%)
 Vcond2: "Vout B Positive" = 20% of "Max Total Aux" and "Vout B Negative" = 80% of "Max Total Aux"
 OR
 "Vout B Positive" = 80% of "Max Total Aux" and "Vout B Negative" = 20% of "Max Total Aux".
6. Converters meet MIL-STD-461 specification revisions for conducted emissions C-CE03 and D-/E-/F-CE-102. The actual value of input ripple current is much less, the limit in the characteristic table is based on measurement resolution.
7. Efficiency measured with all outputs at full load and is the combined efficiency of all outputs.
8. Recovery time is measured from application of the transient to point at which V_{OUT} is within 1% of V_{OUT} at final value
9. Step load test is performed at 10 microseconds typical.
10. The step load specification for the negative auxiliary output is guaranteed by qualification test. It is not an in-line test.
11. Half load to/from full load.
12. Step line test is performed at 100 microseconds \pm 20 microseconds.
13. Measured from release of inhibit or input voltage step.
14. Applies to each auxiliary.
15. Unconditionally stable, start-up delay increased.

SMRT Single, Dual and Triple Space DC-DC Converters

19 TO 56 VOLT INPUT - 23 TO 35 WATT - SPACE QUALIFIED

TYPICAL PERFORMANCE PLOTS: V_{IN} AS SPECIFIED, 25 °C CASE, 100% LOAD, FREE RUN, UNLESS OTHERWISE SPECIFIED. THESE ARE EXAMPLES FOR REFERENCE ONLY AND ARE NOT GUARANTEED SPECIFICATIONS.

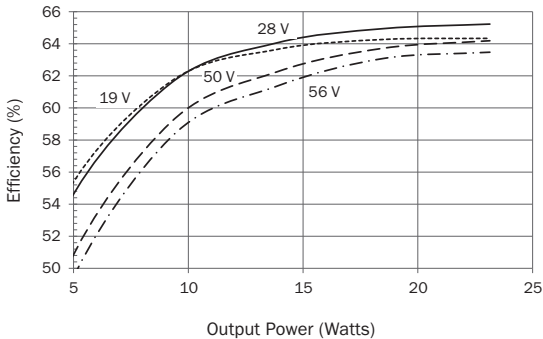

SMRT283R3S Efficiency
FIGURE 8

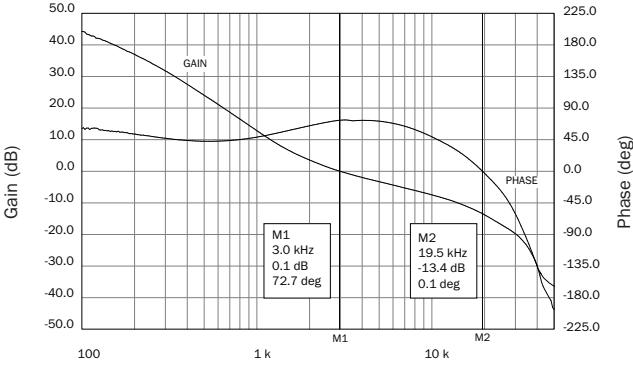

SMRT283R3S Gain Phase
FIGURE 9

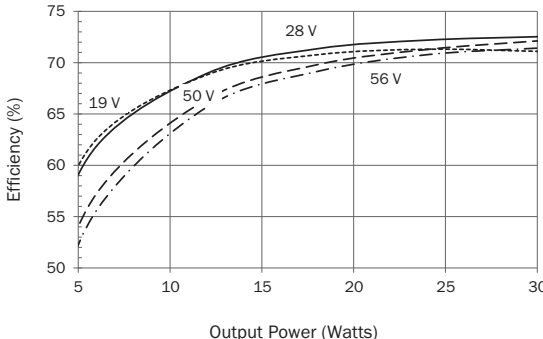

SMRT2805S Efficiency
FIGURE 10

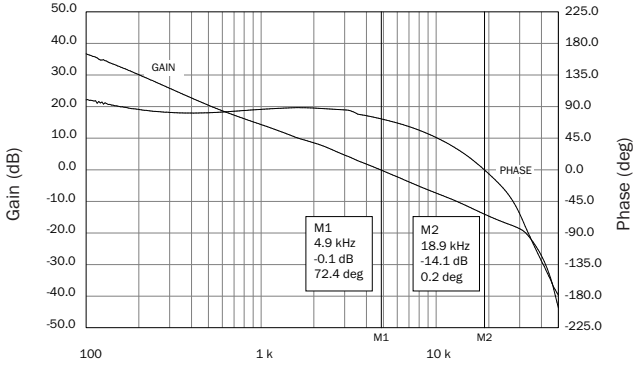

SMRT2805S Gain Phase
FIGURE 11

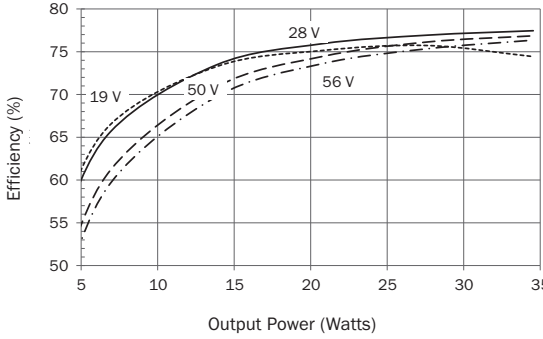

SMRT288R7S Efficiency
FIGURE 12

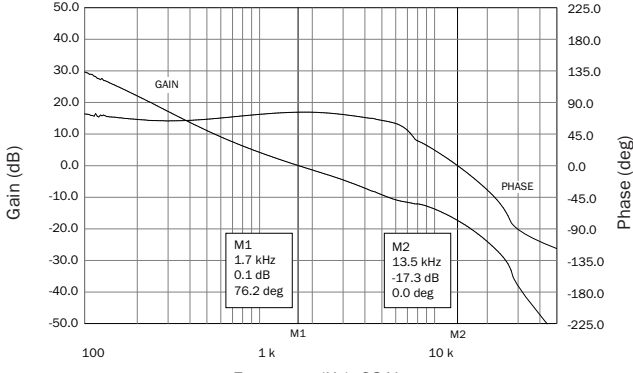

SMRT288R7S Gain Phase
FIGURE 13

SMRT Single, Dual and Triple Space DC-DC Converters

19 TO 56 VOLT INPUT – 23 TO 35 WATT – SPACE QUALIFIED

TYPICAL PERFORMANCE PLOTS: V_{IN} AS SPECIFIED, 25 °C CASE, 100% LOAD, FREE RUN, UNLESS OTHERWISE SPECIFIED. THESE ARE EXAMPLES FOR REFERENCE ONLY AND ARE NOT GUARANTEED SPECIFICATIONS.

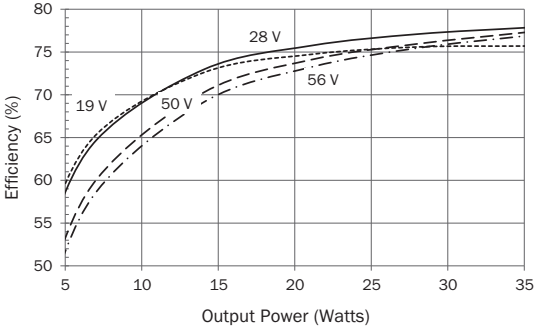

SMRT2812S Efficiency
FIGURE 14

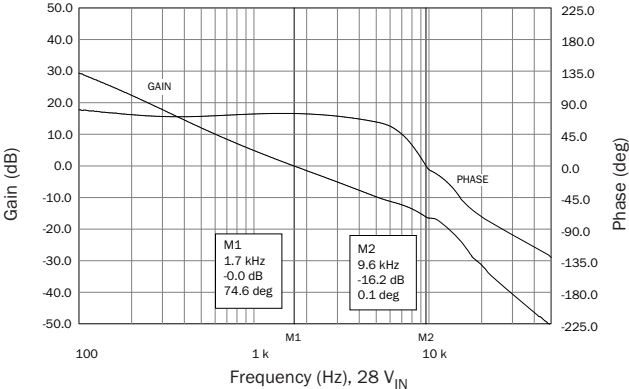

SMRT2812S Gain Phase
FIGURE 15

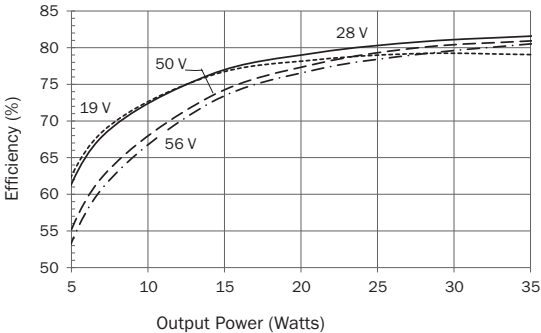

SMRT2815S Efficiency
FIGURE 16

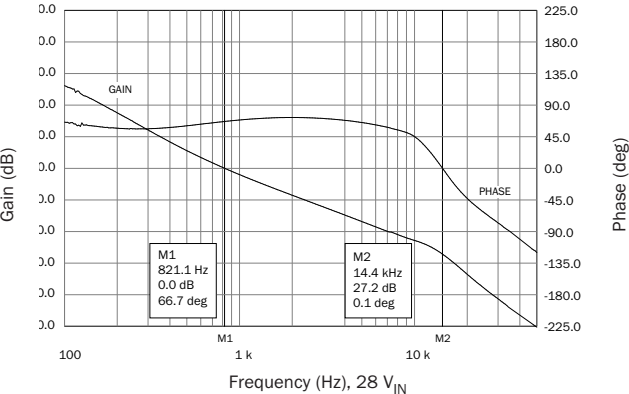

SMRT2815S Gain Phase
FIGURE 17

SMRT Single, Dual and Triple Space DC-DC Converters

19 TO 56 VOLT INPUT – 23 TO 35 WATT – SPACE QUALIFIED

TYPICAL PERFORMANCE PLOTS: V_{IN} AS SPECIFIED, 25 °C CASE, 100% LOAD, FREE RUN, UNLESS OTHERWISE SPECIFIED. THESE ARE EXAMPLES FOR REFERENCE ONLY AND ARE NOT GUARANTEED SPECIFICATIONS.

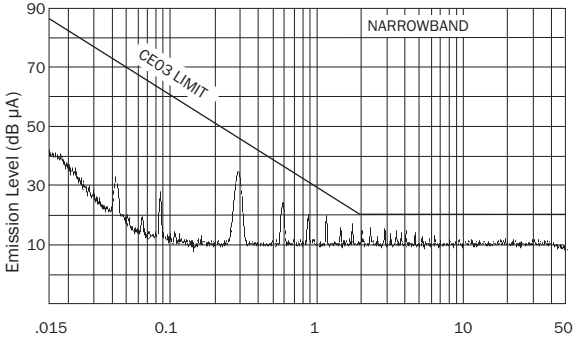

Frequency (MHz), 28 V_{IN}
SMRT Single MIL-STD-461C, CE03
FIGURE 18

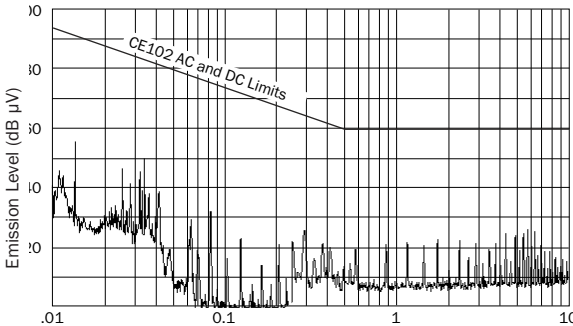

Frequency (MHz), 28 V_{IN}
SMRT Single MIL-STD-461 D-F, CE102
FIGURE 19

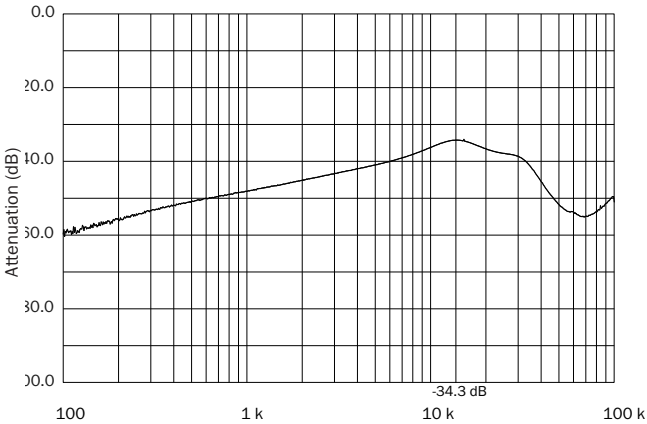

Frequency (Hz), 28 V_{IN}
SMRT Single Audio Rejection
FIGURE 20

SMRT Single, Dual and Triple Space DC-DC Converters

19 TO 56 VOLT INPUT - 23 TO 35 WATT - SPACE QUALIFIED

TYPICAL PERFORMANCE PLOTS: V_{IN} AS SPECIFIED, 25 °C CASE, 100% LOAD, FREE RUN, UNLESS OTHERWISE SPECIFIED. THESE ARE EXAMPLES FOR REFERENCE ONLY AND ARE NOT GUARANTEED SPECIFICATIONS.

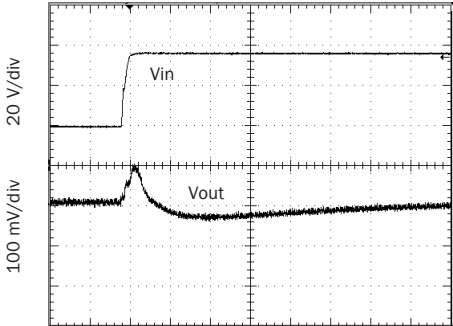

Vin 19 To 56 V, full resistive load

SMRT2805S Representative of Single Output Line Transient

FIGURE 21

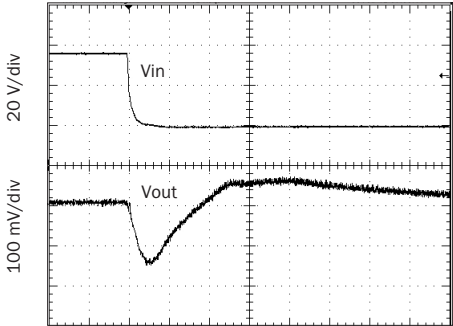

Vin 56 to 19 V, full resistive load

SMRT2805S Representative of Single Output Line Transient

FIGURE 22

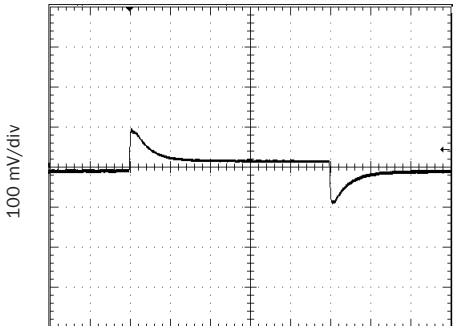

Load 50 - 100 - 50%, 28 Vin

SMRT2805S Representative of Single Output Load Transient

FIGURE 23

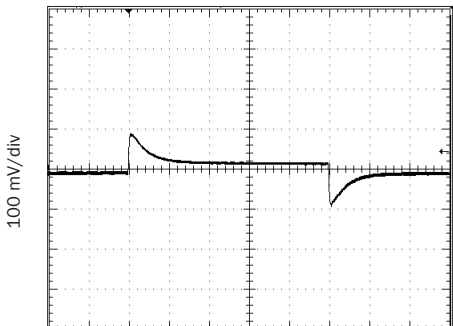

Load 50 - 100 - 50%, 50 Vin

SMRT2805S Representative of Single Output Load Transient

FIGURE 24

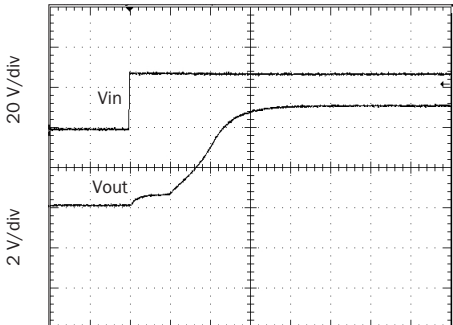

Full resistive load, 28 Vin

SMRT2805S Representative of Single Turn On Delay

FIGURE 25

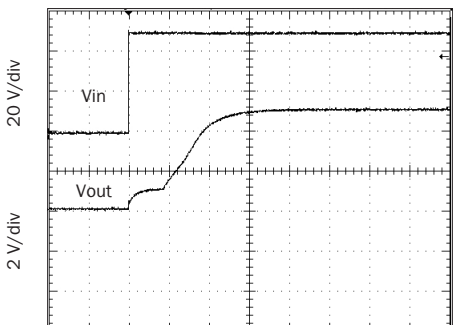

Full resistive load, 50 Vin

SMRT2805S Representative of Single Turn On Delay

FIGURE 26

SMRT Single, Dual and Triple Space DC-DC Converters

19 TO 56 VOLT INPUT – 23 TO 35 WATT – SPACE QUALIFIED

TYPICAL PERFORMANCE PLOTS: V_{IN} AS SPECIFIED, 25 °C CASE, 100% LOAD, FREE RUN, UNLESS OTHERWISE SPECIFIED.
 THESE ARE EXAMPLES FOR REFERENCE ONLY AND ARE NOT GUARANTEED SPECIFICATIONS.

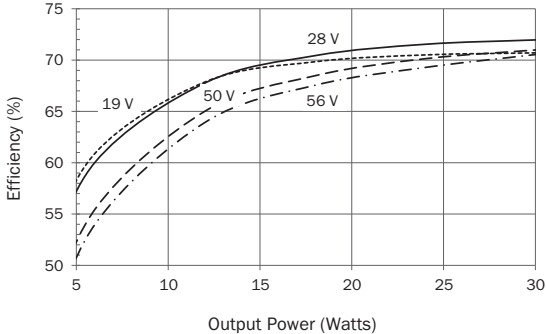

SMRT2805D Efficiency
 FIGURE 27

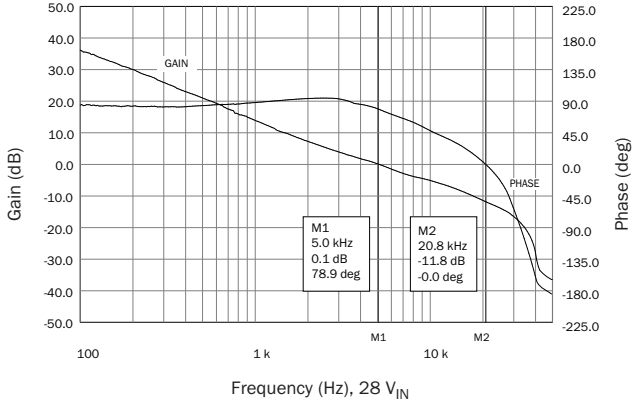

SMRT2805D Gain Phase
 FIGURE 28

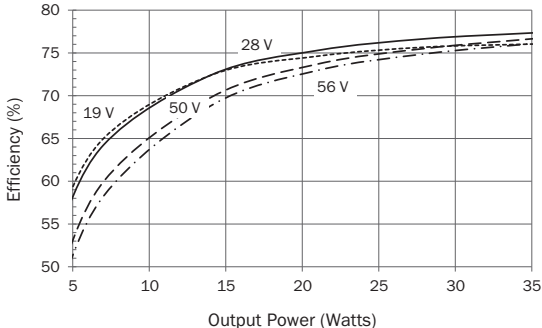

SMRT2812D Efficiency
 FIGURE 29

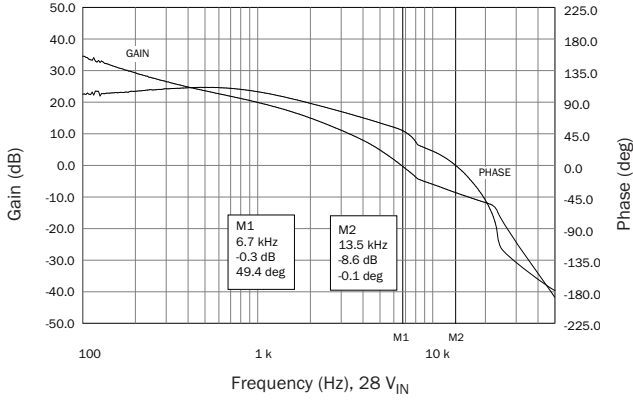

SMRT2812D Gain Phase
 FIGURE 30

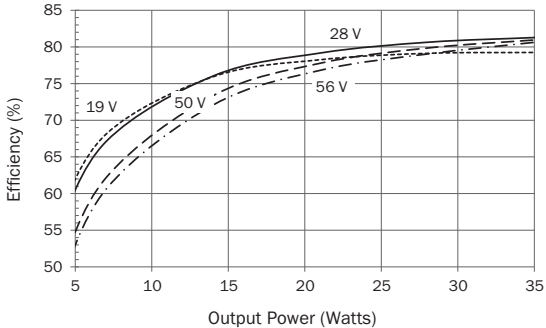

SMRT2815D Efficiency
 FIGURE 31

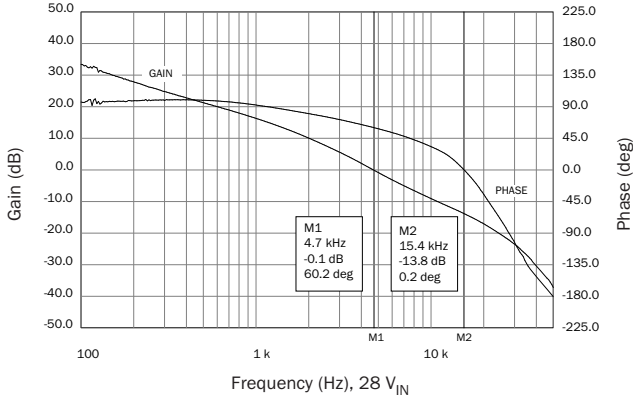

SMRT2815D Gain Phase
 FIGURE 32

SMRT Single, Dual and Triple Space DC-DC Converters

19 TO 56 VOLT INPUT – 23 TO 35 WATT – SPACE QUALIFIED

TYPICAL PERFORMANCE PLOTS: V_{IN} AS SPECIFIED, 25 °C CASE, 100% LOAD, FREE RUN, UNLESS OTHERWISE SPECIFIED. THESE ARE EXAMPLES FOR REFERENCE ONLY AND ARE NOT GUARANTEED SPECIFICATIONS.

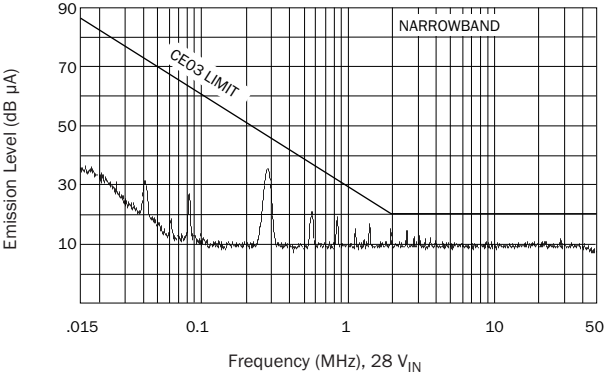

FIGURE 33

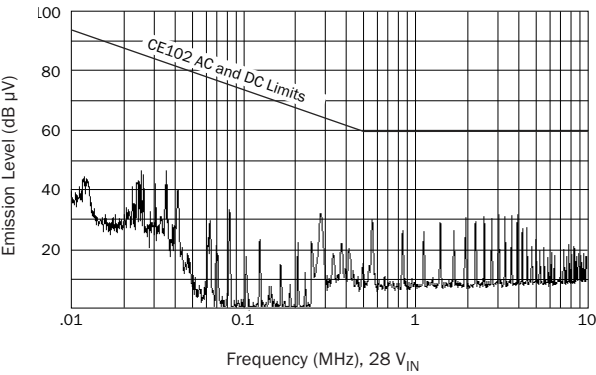

FIGURE 34

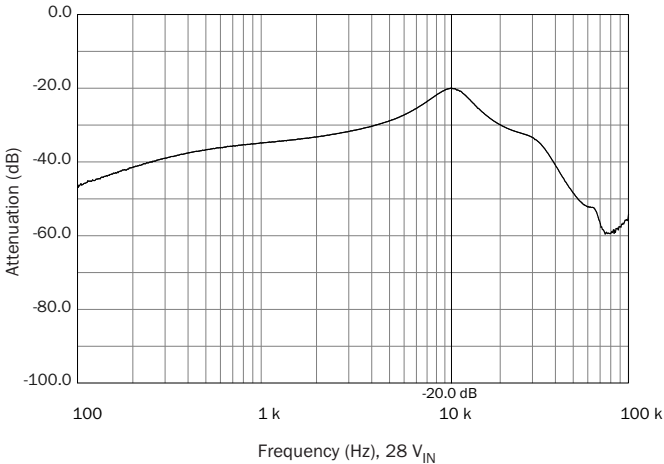

FIGURE 35

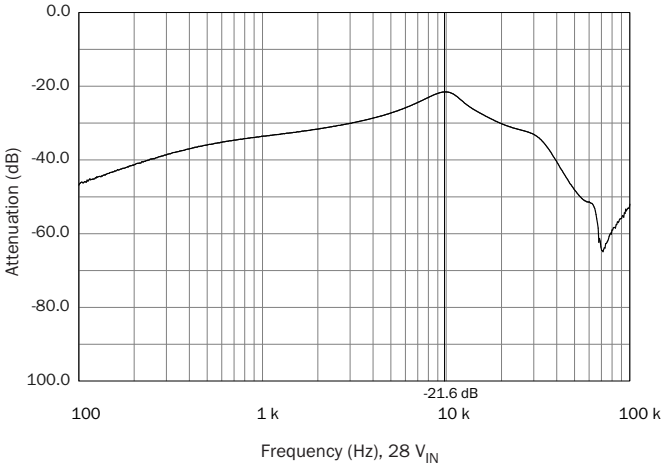
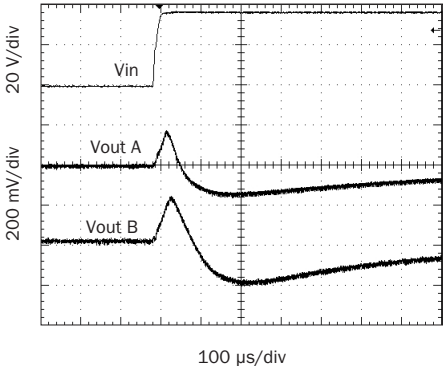

FIGURE 36

SMRT Single, Dual and Triple Space DC-DC Converters

19 TO 56 VOLT INPUT - 23 TO 35 WATT - SPACE QUALIFIED

TYPICAL PERFORMANCE PLOTS: V_{IN} AS SPECIFIED, 25 °C CASE, 100% LOAD, FREE RUN, UNLESS OTHERWISE SPECIFIED. THESE ARE EXAMPLES FOR REFERENCE ONLY AND ARE NOT GUARANTEED SPECIFICATIONS.



Vin 19 to 56 V, full resistive load

SMRT2812D Representative of Dual Output Line Transient
FIGURE 37

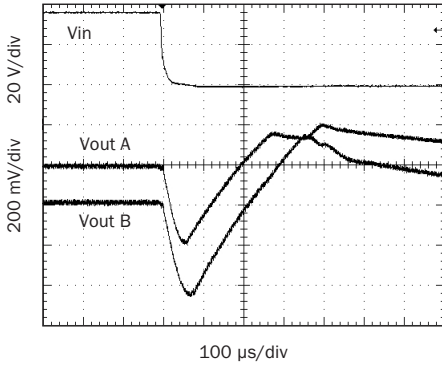

Vin 56 to 19 V, full resistive load

SMRT2812D Representative of Dual Output Line Transient
FIGURE 38

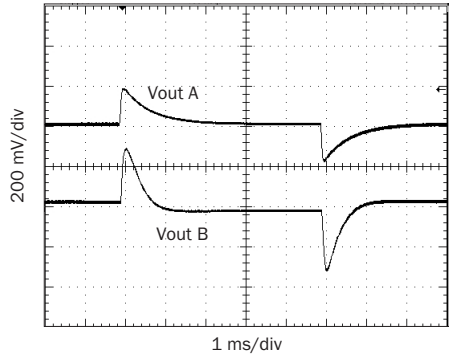

Load 50 - 100 - 50%, 28 Vin

SMRT2812D Representative of Dual Output Load Transient
FIGURE 39

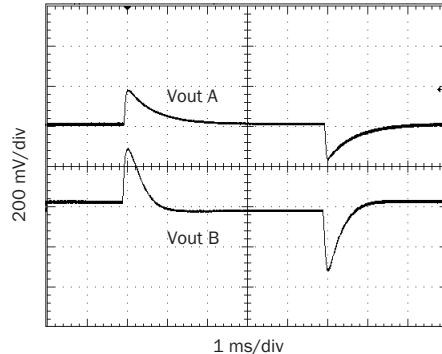

Load 50 - 100 - 50%, 50 Vin

SMRT2812D Representative of Dual Output Load Transient
FIGURE 40

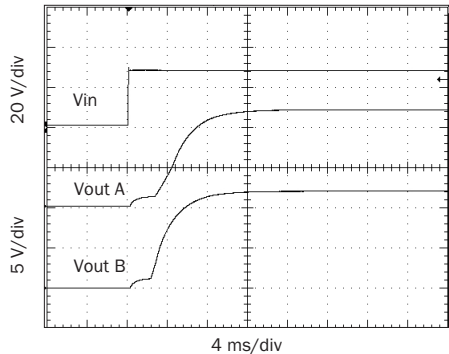

Full resistive load, 28 Vin

SMRT2812D Representative of Dual Turn On Delay
FIGURE 41

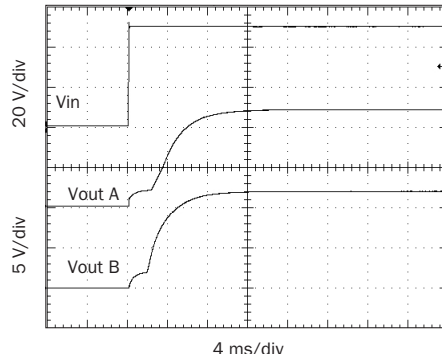

Full resistive load, 50 Vin

SMRT2812D Representative of Dual Turn On Delay
FIGURE 42

SMRT Single, Dual and Triple Space DC-DC Converters

19 TO 56 VOLT INPUT – 23 TO 35 WATT – SPACE QUALIFIED

TYPICAL PERFORMANCE PLOTS: V_{IN} AS SPECIFIED, 25 °C CASE, 100% LOAD, FREE RUN, UNLESS OTHERWISE SPECIFIED. THESE ARE EXAMPLES FOR REFERENCE ONLY AND ARE NOT GUARANTEED SPECIFICATIONS.

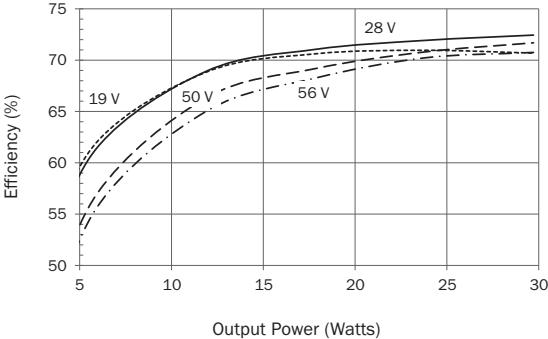

SMRT283R312T Efficiency
FIGURE 43

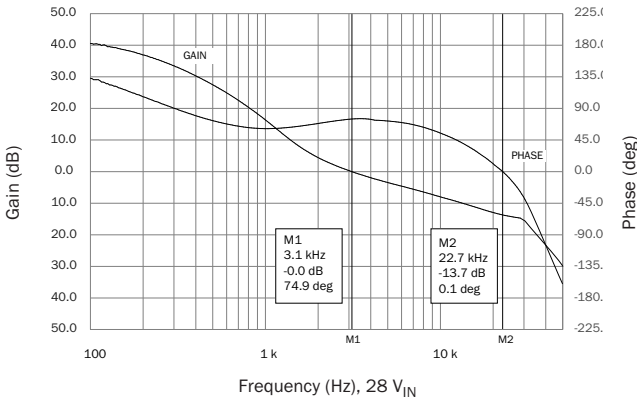

SMRT283R312T Gain Phase, Main Vout
Representative of all 3.3 V Main models
FIGURE 44

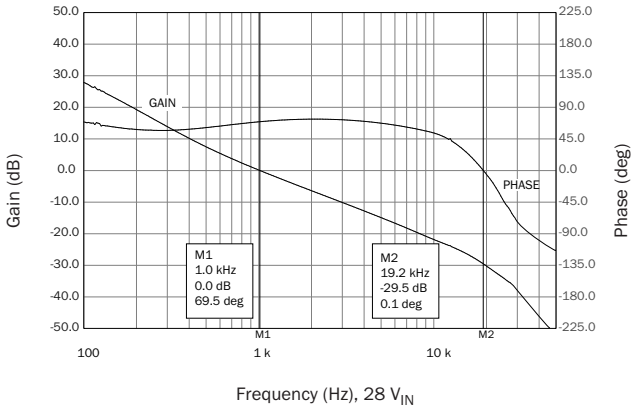

SMRT283R312T Gain Phase, +Aux
Representative of all 12 V +Aux models
FIGURE 45

SMRT Single, Dual and Triple Space DC-DC Converters

19 TO 56 VOLT INPUT - 23 TO 35 WATT - SPACE QUALIFIED

TYPICAL PERFORMANCE PLOTS: V_{IN} AS SPECIFIED, 25 °C CASE, 100% LOAD, FREE RUN, UNLESS OTHERWISE SPECIFIED. THESE ARE EXAMPLES FOR REFERENCE ONLY AND ARE NOT GUARANTEED SPECIFICATIONS.

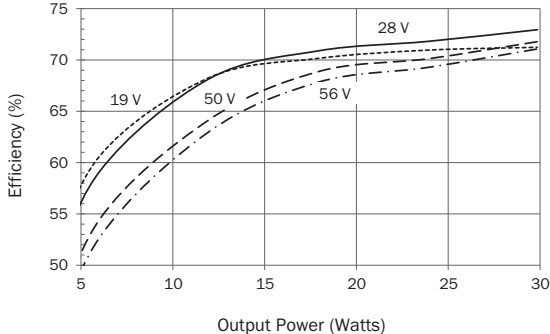

SMRT283R315T Efficiency

FIGURE 46

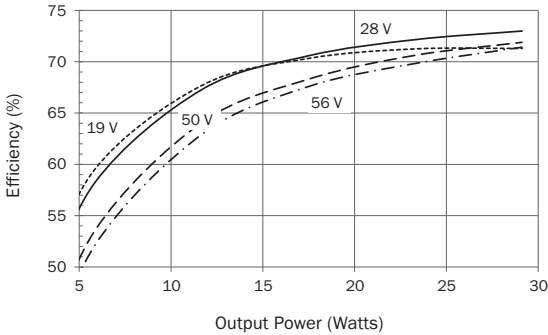

SMRT28507T Efficiency

FIGURE 47

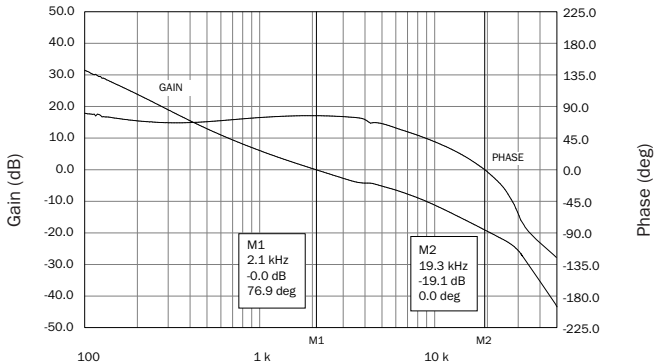

SMRT28507T Gain Phase, +Aux

FIGURE 48

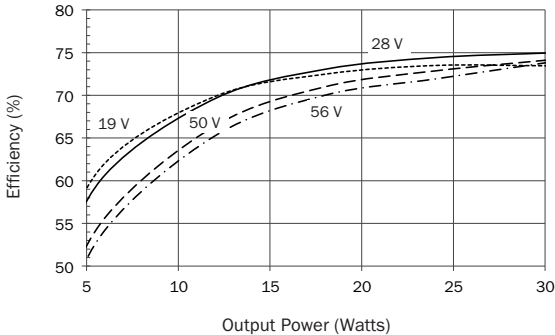

SMRT28512T Efficiency

FIGURE 49

SMRT Single, Dual and Triple Space DC-DC Converters

19 TO 56 VOLT INPUT – 23 TO 35 WATT – SPACE QUALIFIED

TYPICAL PERFORMANCE PLOTS: V_{IN} AS SPECIFIED, 25 °C CASE, 100% LOAD, FREE RUN, UNLESS OTHERWISE SPECIFIED.
 THESE ARE EXAMPLES FOR REFERENCE ONLY AND ARE NOT GUARANTEED SPECIFICATIONS.

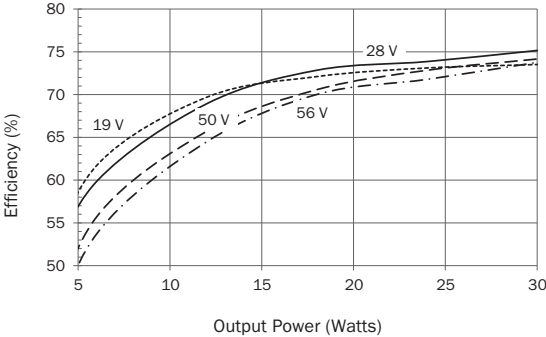

SMRT28515T Efficiency
 FIGURE 50

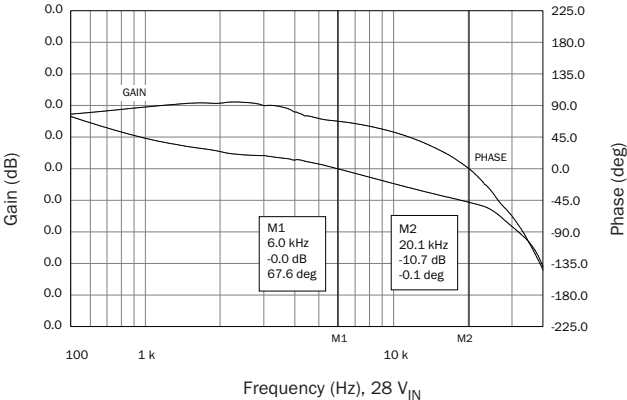

SMRT28515T Gain Phase, Main Vout
 Representative of all 5 V Main models
 FIGURE 51

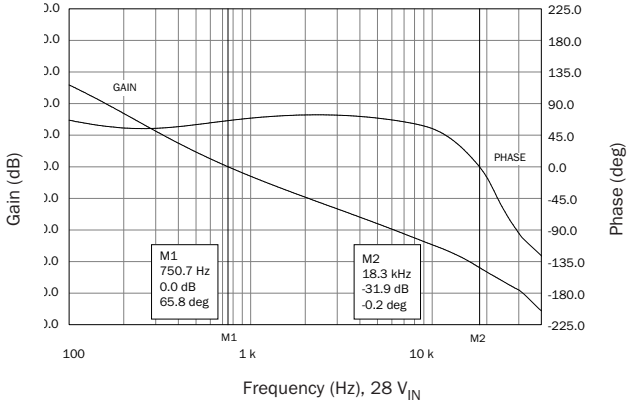

SMRT28515T Gain Phase, +Aux
 Representative of all 15 V +Aux models
 FIGURE 52

SMRT Single, Dual and Triple Space DC-DC Converters

19 TO 56 VOLT INPUT – 23 TO 35 WATT – SPACE QUALIFIED

TYPICAL PERFORMANCE PLOTS: V_{IN} AS SPECIFIED, 25 °C CASE, 100% LOAD, FREE RUN, UNLESS OTHERWISE SPECIFIED. THESE ARE EXAMPLES FOR REFERENCE ONLY AND ARE NOT GUARANTEED SPECIFICATIONS.

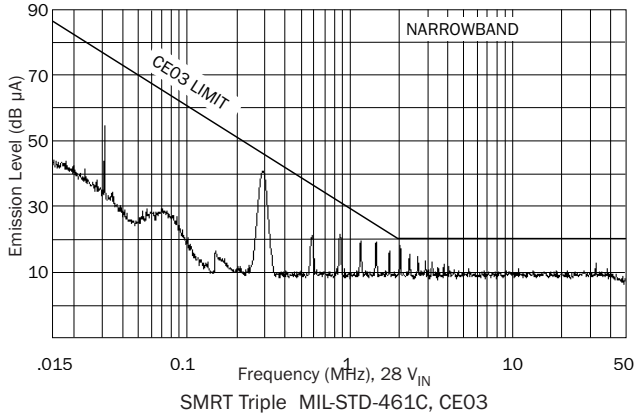

FIGURE 53

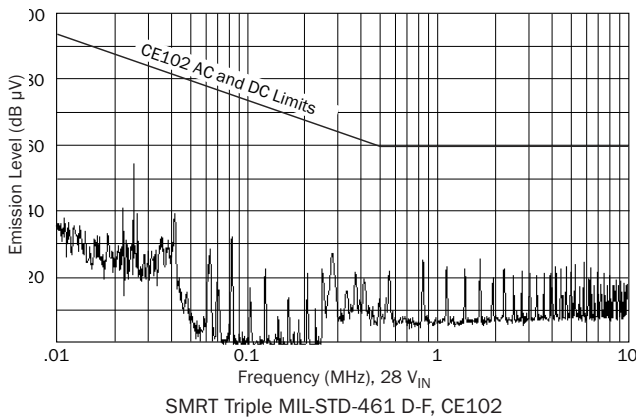

FIGURE 54

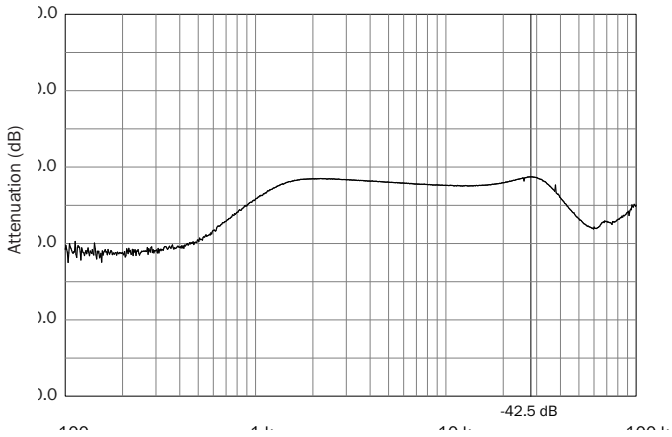

FIGURE 55

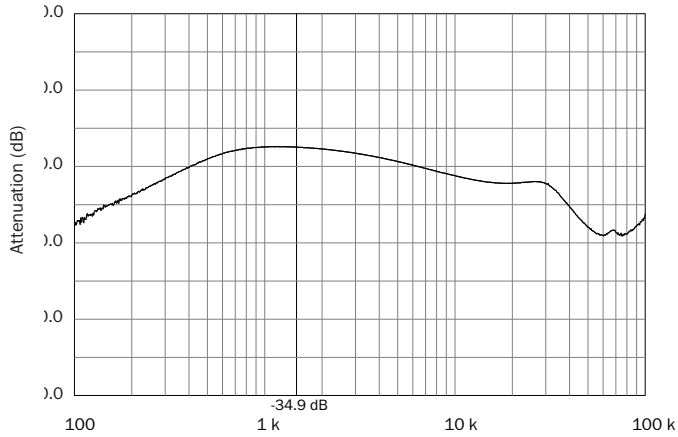
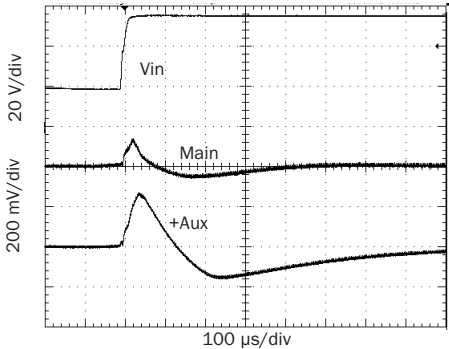

FIGURE 56

SMRT Single, Dual and Triple Space DC-DC Converters

19 TO 56 VOLT INPUT - 23 TO 35 WATT - SPACE QUALIFIED

TYPICAL PERFORMANCE PLOTS: V_{IN} AS SPECIFIED, 25 °C CASE, 100% LOAD, FREE RUN, UNLESS OTHERWISE SPECIFIED.
 THESE ARE EXAMPLES FOR REFERENCE ONLY AND ARE NOT GUARANTEED SPECIFICATIONS.



Vin 19 to 56 V, full resistive load
 SMRT283R312T Representative of
 Triple Output Line Transient
 FIGURE 57

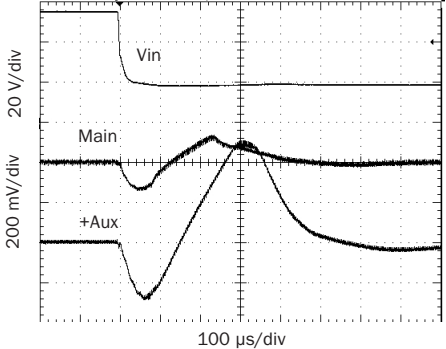

Vin 56 to 19 V, full resistive load
 SMRT283R312T Representative of
 Triple Output Line Transient
 FIGURE 58

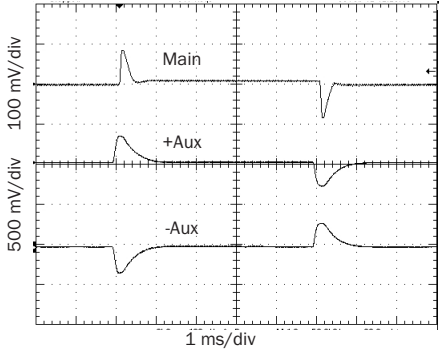

Load 50 - 100 - 50%, 28 Vin
 SMRT283R312T Representative of
 Triple Output Load Transient
 FIGURE 59

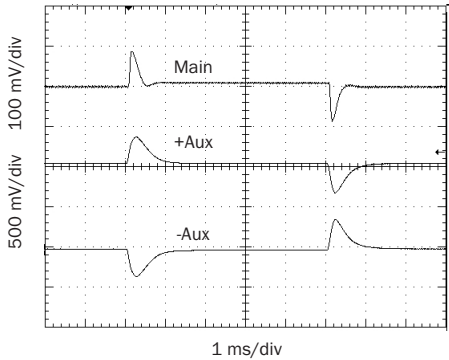

Load 50 - 100 - 50%, 50 Vin
 SMRT283R312T Representative of
 Triple Output Load Transient
 FIGURE 60

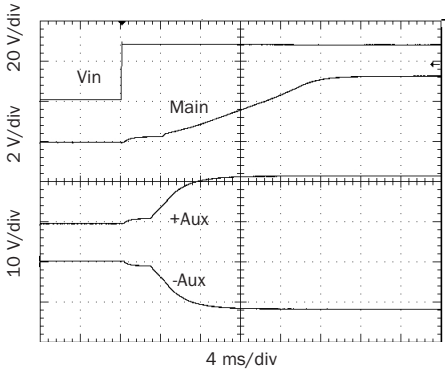

Full resistive load, 28 Vin
 SMRT283R312T Representative of
 Triple Output Turn On Delay
 FIGURE 61

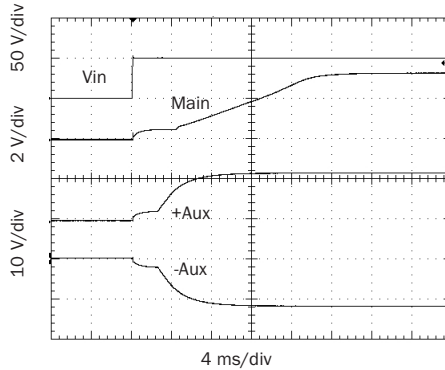

Full resistive load, 50 Vin
 SMRT283R312T Representative of
 Triple Output Turn On Delay
 FIGURE 62

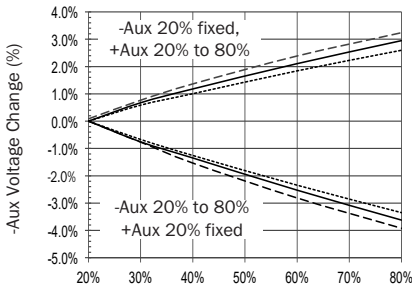

+Aux Load (%), 28 V_{IN}
 -55 °C — 25 °C - -125 °C
 SMRT283R312T Cross Regulation
 FIGURE 63

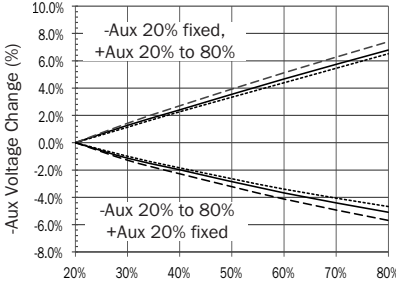

+Aux Load (%), 28 V_{IN}
 -55 °C — 25 °C - -125 °C
 SMRT28507T Cross Regulation
 FIGURE 64

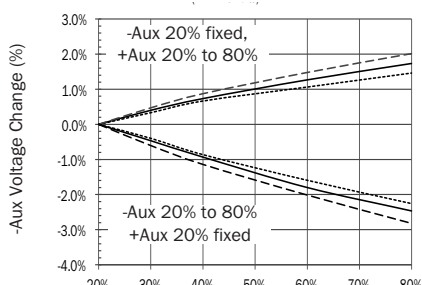

+Aux Load (%), 28 V_{IN}
 -55 °C — 25 °C - -125 °C
 SMRT28515T Cross Regulation
 FIGURE 65

SMRT Single, Dual and Triple Space DC-DC Converters

19 TO 56 VOLT INPUT - 23 TO 35 WATT - SPACE QUALIFIED

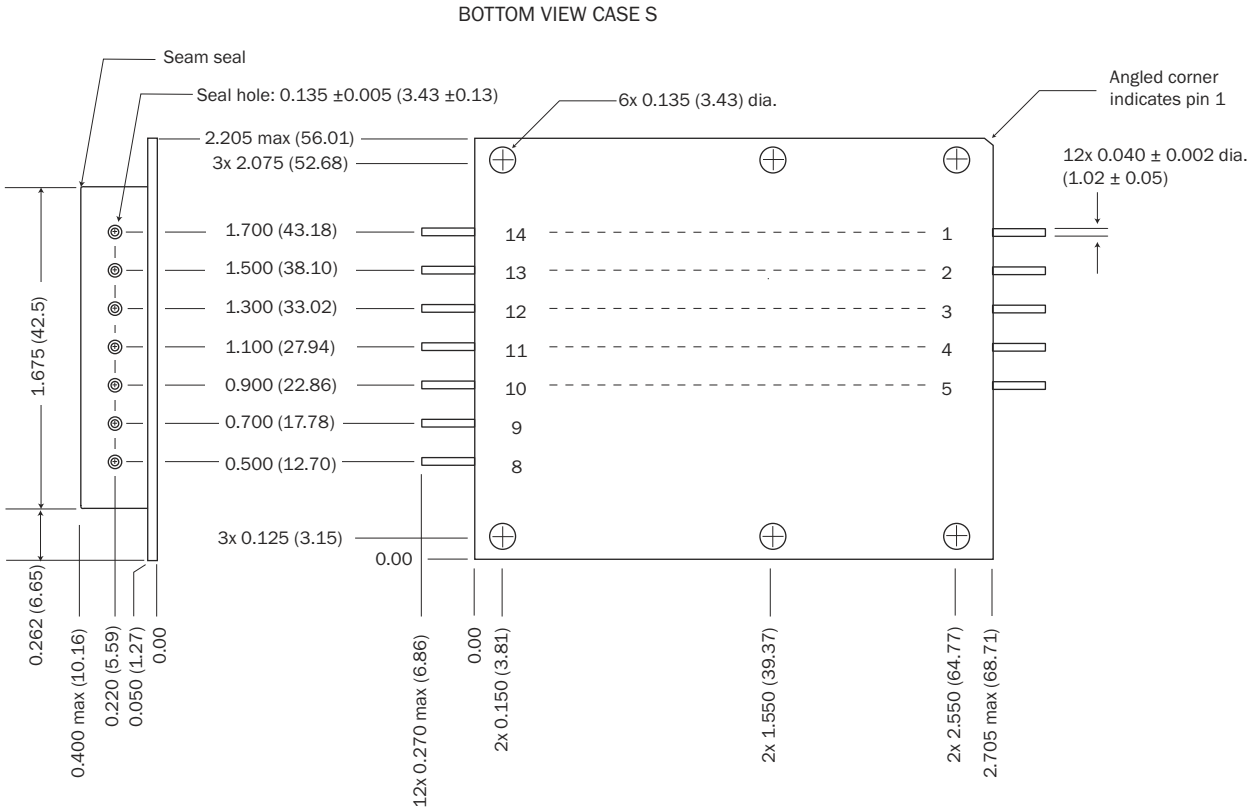

Weight: 100 gms maximum

Case dimensions in inches (mm)
Tolerance ±0.005 (0.13) for three decimal places
±0.01 (0.3) for two decimal places
unless otherwise specified

CAUTION
Heat from reflow or wave soldering may damage the device.
Solder pins individually with heat application not exceeding 300 °C for 10 seconds per pin

Materials
Header Cold Rolled Steel/Nickel, Gold Plated
Cover Kovar/Nickel
Pins #52 alloy/gold, ceramic seal
Gold plating of 50 - 150 microinches included in pin diameter
Seal hole 0.123 ± 0.002 (3.12 ± 0.051)

Please refer to the numerical dimensions for accuracy.

FIGURE 66: CASE S

SMRT Single, Dual and Triple Space DC-DC Converters

19 TO 56 VOLT INPUT – 23 TO 35 WATT – SPACE QUALIFIED

ELEMENT EVALUATION TABLES FOR QML PRODUCTS ARE IN “APP-009 QUALITY AND CERTIFICATION”, APPENDIX A, IN COMPLIANCE WITH MIL-PRF-38534 REVISION L.
(LINK [HTTPS://WWW.CRANEEAE.COM/QUALITY-ASSURANCE-MODULAR-POWER](https://www.craneeae.com/quality-assurance-modular-power))

ENVIRONMENTAL SCREENING SPACE DC-DC CONVERTERS PROTOTYPE, CLASS H AND K

TEST PERFORMED	NON-QML ¹	QML ^{2, 3}		
	PROTOTYPE (/O) ⁴	CLASS H (/H)	CLASS E (/E) ⁵	CLASS K (/K)
Non-destruct wire bond pull, Method 2023		■ ⁶	■	■
Pre-cap Inspection, Method 2017, 2032	■	■	■	■
Temperature Cycle (10 times) Method 1010, Cond. C, -65°C to +150°C, ambient	■	■	■	■
Constant Acceleration Method 2001, 3000 g	■	■	■	■
PIND, Test Method 2020, Cond. A		■ ⁶	■	■
Pre burn-in test, Group A, Subgroups 1 and 4	■	■ ⁶	■	■
Burn-in Method 1015, +125°C case, typical ⁷				
96 hours	■			
160 hours		■		
2 x 160 hours (includes mid-BI test)			■	■
Final Electrical Test, MIL-PRF-38534, Group A,				
Subgroups 1 and 4: +25°C case	■			
Subgroups 1 through 6, -55°C, +25°C, +125°C case		■	■	■
Hermeticity Test, Method 1014				
Gross Leak, Cond. B ₂ , Kr85			■	■
Gross Leak, Cond. C ₁ , fluorocarbon	■	■		
Fine Leak, Cond. B ₁ , Kr85			■	■
Fine Leak, Cond. A ₂ , helium	■	■		
Radiography, Method 2012			■	■
Post Radiography Electrical Test, +25°C case			■ ⁶	■ ⁶
Final visual inspection				
Method 2009 of MIL-STD-883		■	■	■
Magnification 1X ⁸	■			

Test methods are referenced to MIL-STD-883 as determined by MIL-PRF-38534.

Notes

1. Non-QML prototype products may not meet all of the requirements of MIL-PRF-38534.
2. All processes are QML qualified and performed by certified operators.
3. Class H or K QML products that have no SMD number are marked “CHP, CHL, CHR, CKP, CKL or CKR” per MIL-PRF-38534, Table III instead of “QML”.
4. “O” in the RHA designator position in Interpoint model numbers indicates DLA RHA “-” defined as no RHA.
5. Class E is based on Class K requirements of MIL-PRF-38534 with the exception that Constant Acceleration is limited to 3000 g maximum including qualification testing.
6. Not required by DLA but performed to assure product quality.
7. Burn-in temperature designed to bring the case temperature to +125°C minimum. Burn-in is a powered test.
8. Visual inspection is performed per an internal document. Product may contain cosmetic irregularities such as dents, dings, scratches, etc. that do not affect form, fit or function.

TABLE 27: ENVIRONMENTAL SCREENING SPACE DC-DC CONVERTERS PROTOTYPE, CLASS H, E AND K

SMRT Single, Dual and Triple Space DC-DC Converters

19 TO 56 VOLT INPUT – 23 TO 35 WATT – SPACE QUALIFIED

SPACE RADIATION HARDNESS ASSURANCE DC-DC CONVERTERS CLASS H, E AND K, RHA ¹ P, L AND R

QUALIFICATION PER MIL-STD	QML ²								
	CLASS H			CLASS E ³			CLASS K		
	/HP	/HL	/HR	/EKP	/EKL	/EKR	/KP	/KL	/KR
RHA P: 30 krad(Si) total dose ^{1, 4, 5}	■			■			■		
RHA L: 50 krad(Si) total dose ^{1, 4, 5}		■			■			■	
RHA R: 100 krad(Si) total dose ^{1, 4, 5}			■			■			■
SEE, LET 86 MeV cm²/mg ^{1, 6}	■	■	■	■	■	■	■	■	■

Test methods are referenced to MIL-STD-883 as determined by MIL-PRF-38534.

- Notes
1. Crane facility has a DLA approved RHA plan for Interpoint power products. Our SMD products with RHA "P", "L" or "R" code meet DLA requirements.
 2. Class H or K QML products that have no SMD number are marked "CHP, CHL, CHR, CKP, CKL or CKR" per MIL-PRF-38534, Table III instead of "QML".
 3. Class E is based on Class K requirements of MIL-PRF-38534 with the exception that Constant Acceleration is limited to 3000 g maximum including qualification testing.
 4. Radiation sensitive components internal to the devices are procured with radiation guarantees or undergo radiation lot acceptance testing (RLAT) performed per condition A, method 1019 of MIL-STD-883.
 5. Representative devices were initially High Dose Rate (HDR) tested using condition A of method 1019 of MIL-STD 883 to ensure RHA designator levels. Representative devices have also been Low Dose Rate (LDR) tested using condition D of method 1019 of MIL-STD-883 to the RHA designator levels. Representative devices will also be re-tested after design or process changes that can affect RHA response of this device.
 6. Single event testing was performed on a converter to 86 MeV-cm²/mg using 15 MeV/ nucleon gold ions with no latch-up, burn-out, functional interrupts, or gate ruptures exhibited. Single event upsets (output voltage transients) may be present up to 86 MeV-cm²/mg.

TABLE 28: SPACE RADIATION HARDNESS ASSURANCE DC-DC CONVERTERS CLASS H, E AND K, RHA P, L AND R

SMRT Single, Dual and Triple Space DC-DC Converters

19 TO 56 VOLT INPUT – 23 TO 35 WATT – SPACE QUALIFIED

Acronym	Definition
HDR	high dose rate
LDR	low dose rate
LET	linear energy transfer
MeV	megaelectron volts
RHA	radiation hardness assurance
SEE	single event effect
SEGR	single event gate rupture
SEL	single event latch-up
SET	single event transient
SEU	single event upset
TID	total ionizing dose

TABLE 29: RHA ACRONYMS

SMRT28 Single, Dual and Triple Series, SMRT28 Rev AT - 2021.04.26. This revision supersedes all previous releases. All technical information is believed to be accurate, but no responsibility is assumed for errors or omissions. Crane Electronics, Inc. reserves the right to make changes that do not affect form, fit or function of Class H or K products or specifications without notice. Interpoint is a registered trademark of Crane Co. and SMRT Series is a trademark of Crane Electronics, Inc. Copyright © 2005-2021 Crane Electronics, Inc. All rights reserved. www.craneae.com/interpoint

