

# MFX Single Output DC-DC Converters

## 16 TO 50 VOLT INPUT - 50 WATT

### FEATURE

- 89 to 93% typical efficiency
- Wide input range, 16 to 50 volts
- $\pm 10\%$  trimmable outputs
- Transient protection up to 80 volts per MIL-STD-704A
- Fully isolated, magnetic feedback
- $-55^{\circ}\text{C}$  to  $+125^{\circ}\text{C}$  operation
- Undervoltage lockout
- Inhibit function
- Soft-start function limits inrush current during start-up



MODELS
OUTPUT VOLTAGE (V)
SINGLE
3.3
5
9
12
15

### DESCRIPTION

The Interpoint® MFX Series™ of high efficiency DC-DC converters offers a wide input voltage range of 16 to 50 volts and up to 50 watts of output power. The MFX converters are manufactured in our fully certified and qualified MIL-PRF-38534 Class H production facility and packaged in hermetically sealed steel cases. They are ideal for use in programs requiring high reliability, small size, and high efficiency. These converters are capable of withstanding short term transients up to 80 volts per MIL-STD-704A. Flanged and non-flanged models are available.

### CONVERTER DESIGN

The MFX converters are switching regulators that use an active-clamp reset, single-ended forward converter and synchronous rectification design with a constant switching frequency of 500 kHz, typical. Isolation between input and output circuits is provided with transformers in the power path and in the feedback control loop. The converter design is further described in sections “Operation” and “Control” on page 2.

### HIGH POWER DENSITY

The MFX Series offers a new standard of performance for small size and high power density. At just 0.426 inches (10.82 mm) high and a total footprint of 2.34 in<sup>2</sup> (15 cm<sup>2</sup>), this low profile package offers a total power density of approximately 50 watts per cubic inch.

### AUDIO REJECTION AND FILTERS

The MFX converters current mode control system provides excellent dynamic response and audio rejection. See Figure 17 on page 16.

The MFX Series converters implement an internal input filtering to reduce emissions to a level acceptable for many applications. For applications required to meet MIL-STD-461C CE03 and/or MIL-STD-461D, E and F CE102 levels of conducted emission consider the Interpoint FMCE family of EMI filters. Any of our Interpoint FMCE filters can be used to the rated current of the filter.

### INHIBIT FUNCTION

MFX converters provide an inhibit terminal that can be used to disable internal switching, resulting in no output and very low quiescent input current. The converter is inhibited when the inhibit pin is pulled to 0.8 volts or less. The unit is enabled when the pin, which is internally connected to a pull-up current source, is left unconnected or is connected to an open-collector. The open circuit voltage associated with the inhibit pin is 14 to 18 volts. The inhibit pin may sink up to 4 mA maximum when driven to an active low condition. See Table 5 on page 9 for more information.

### PROTECTION FEATURES

All models include a soft-start function to prevent large current draw and minimize overshoot. The converters provide short circuit protection (by restricting the current) and output overload protection.

MFX Series converters provide short circuit protection by restricting the output current to approximately 130% of the full load output current. See “Output Overload and Short Circuit Protection” for more details.

### UNDERVOLTAGE LOCKOUT

Undervoltage lockout with hysteresis prevents the units from operating below approximately 15 volts input voltage to keep system current levels smooth, especially during initialization or re-start operations.

# MFX Single Output DC-DC Converters

## 16 TO 50 VOLT INPUT - 50 WATT

### OPERATION

The MFX is a single-ended, active clamp, forward DC-DC converter. The active-clamp reset technique offers several advantages for wide input voltage range compared to other passive reset methods. It reduces switching losses and lowers the voltage stress on the power switch. The efficiency can then be improved by selecting MOSFETs with lower voltage rating which provides lower on-state resistance.

Rectification is typically performed using ultrafast diodes or Schottky diodes. The conduction loss on such rectifiers can become a significant portion of the total power loss for low-voltage output and high-power applications. To maximize the benefits of active-clamp reset the MFX is designed with self-driven synchronous rectifiers (SDSR) to reduce the conduction losses. The MFX employs a unique synchronous gate-drive circuitry that automatically adjusts for the wide input voltage range.

Under operating conditions when the PWM is not switching the MFX can sink current from an external voltage source applied to its output. This behavior is inherent to the SDSR in the MFX. To prevent damage to the converters, do not use them with pre-bias startup, load current sharing or parallel operation. These characteristics are discussed in the “Control” on page 2 below.

### CONTROL

#### SHUTDOWN

In normal operation, the output capacitors are charged at the regulated output voltage and can be used for holdup purposes. When the MFX converter is turned off either through removal of the input line voltage or assertion of inhibit, the synchronous rectifiers will continue to switch until the total energy stored in the internal and external output capacitors is safely depleted. Due to this behavior the energy in the output capacitor will be discharged and may not be suitable for holdup applications.

#### EFFECTS OF EXTERNAL VOLTAGE SOURCE AND PRE-BIAS STARTUP

Do not apply an external voltage source across the MFX converter output as it may turn on the self driven synchronous rectification (SDSR) causing the converter to sink current from the source. The MFX converters do not support pre-biased startup applications. The converter will sink current from the load and may not startup if an external bias is present on the output of the converter

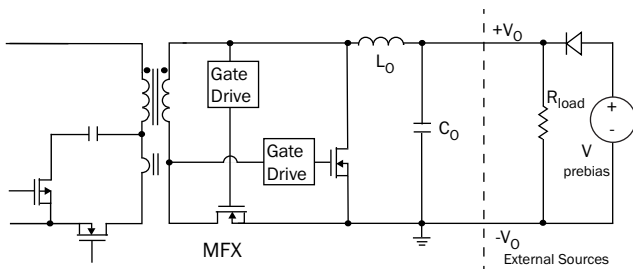

FIGURE 1: PRE-BIAS STARTUP IS NOT SUPPORTED

### OUTPUT AND REMOTE SENSE CONNECTIONS

Care must be taken to avoid accidental disconnection of the Positive Output (Pins 5, 6) or Output Common (Pins 3, 4) when Remote Sense is used. If the sense pins are connected to the load, but the output power pins are not connected to the load, then the converter may be damaged.

### LOAD SHARING AND STACKING CAN DAMAGE THE CONVERTER

The MFX converters do not support load current sharing or parallel operation. The converters can be damaged if their outputs are directly connected per Figure 2.

MFX converters do not support stacking voltages.

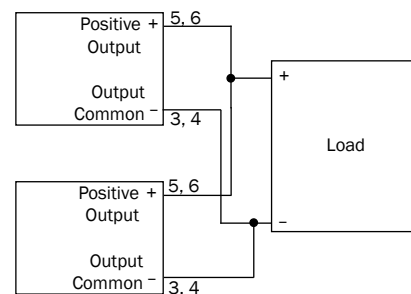

FIGURE 2: THE MFX CONVERTERS CAN BE DAMAGED IF CONNECTED TOGETHER FOR LOAD CURRENT SHARING

(See following pages for “Redundancy”, “Inhibit” and “Output Overload and Short Circuit Protection”)

# MFX Single Output DC-DC Converters

## 16 TO 50 VOLT INPUT - 50 WATT

### REDUNDANCY

In redundant systems, multiple converters are used in parallel to provide uninterrupted power and to improve reliability. This can be implemented by connecting ORing diodes on the output of each converter per Figure 3. The diode provides isolation of the converter from the load and other converters in the event of a failure. The ORing diodes also provide redundancy in the event that a converter turns off earlier or turns on later than the others. When the MFX is used with ORing diodes, the remote sense connections on the MFX converters must be connected locally to the individual converter's output and cannot be connected to the cathode of the ORing diodes. Redundancy can instead be achieved with active ORing using power MOSFETs and controller IC, which can reduce thermal dissipation and improve system efficiency. The MFX converters cannot be used with MOSFETs for ORing purposes unless only one device is active at any given time. This requires an ORing MOSFET controller that can selectively disable all ORing MOSFETs except for one operational unit.

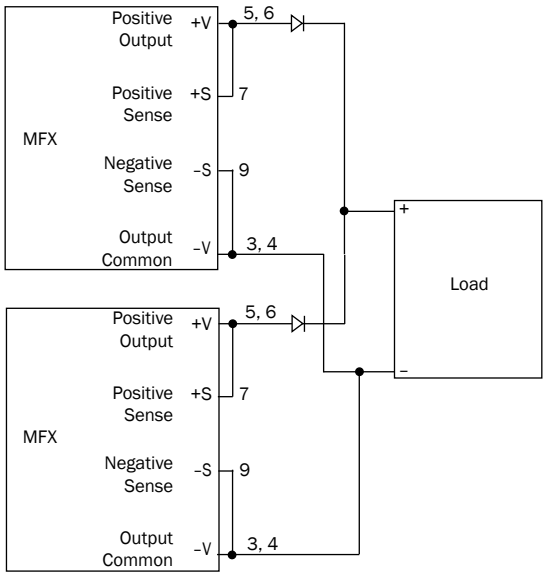
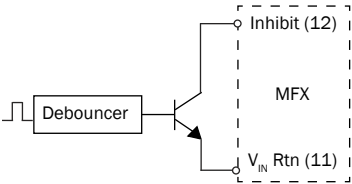

FIGURE 3: REDUNDANCY USING ORING DIODES

### INHIBIT

The MFX converter can be inhibited by pulling the inhibit pin low using an open-collector connection. The inhibit pin is internally connected to a pull-up with a typical open-pin voltage of 16 volts. Following a shutdown event by assertion of the inhibit function the assert to de-assert delay time must be at least 10 ms for no capacitive loading and 150 ms for maximum capacitive loading. The inhibit signal to the inhibit pin must also use debounce circuitry to prevent rapid turn-off and turn-on as this may cause damage to the converter.



Typical interface inhibit referenced to input

FIGURE 4: TYPICAL INHIBIT INTERFACE (DELAY NOT ADDED)

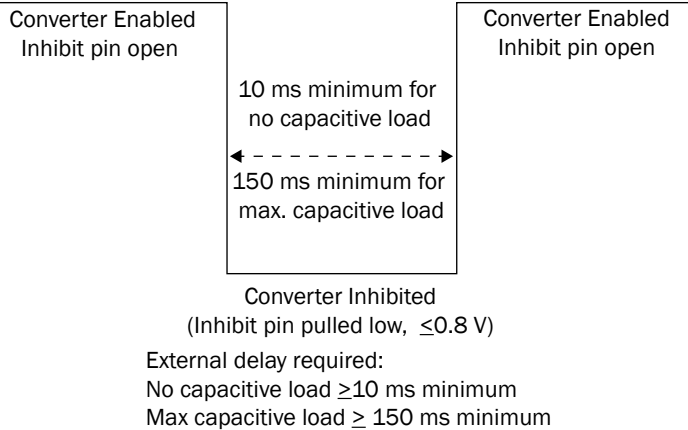

FIGURE 5: DELAY TIME FROM ASSERT TO DE-ASSERT FOR INHIBIT

# MFX Single Output DC-DC Converters

## 16 TO 50 VOLT INPUT - 50 WATT

### OUTPUT OVERLOAD AND SHORT-CIRCUIT PROTECTION

The MFX converters are protected against indefinite short circuit when the short circuit output voltage is less than 200 mV. To maximize efficiency, the converters use a forward topology with active-clamp reset and SDSR. Inherent to the combination of active-clamp reset and SDSR is the catch or freewheeling MOSFET will dissipate excess power through its body-diode during output overload. For this reason, operating continuously beyond the current limit trip point may damage or substantially shorten the life of these converters. The figure below shows the overload characteristics of the output voltage versus output current. To prevent damage, the converters should not operate in overload for more than 100 ms. For more information or application support, email [powerapps@crane-eg.com](mailto:powerapps@crane-eg.com).

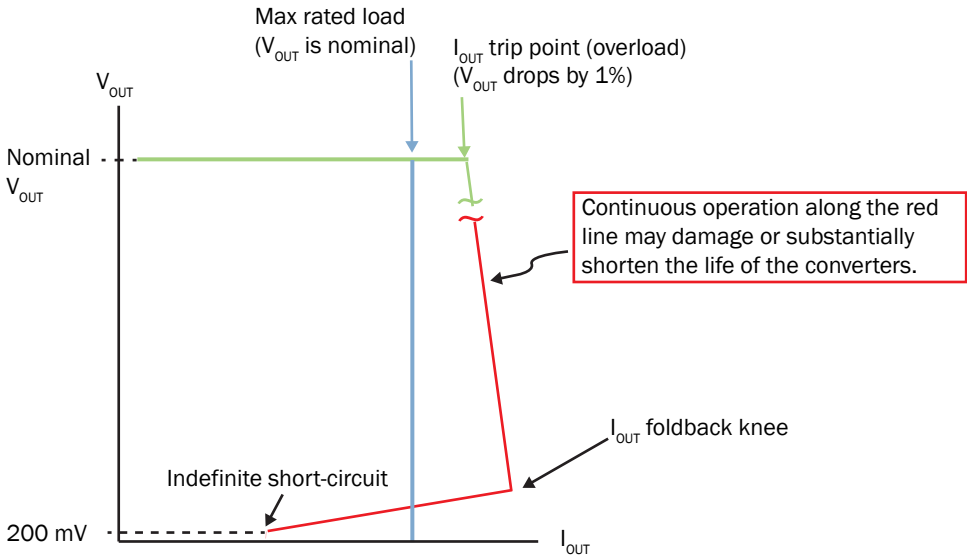

FIGURE 6: OUTPUT OVERLOAD AND SHORT CIRCUIT

# MFX Single Output DC-DC Converters

16 TO 50 VOLT INPUT - 50 WATT

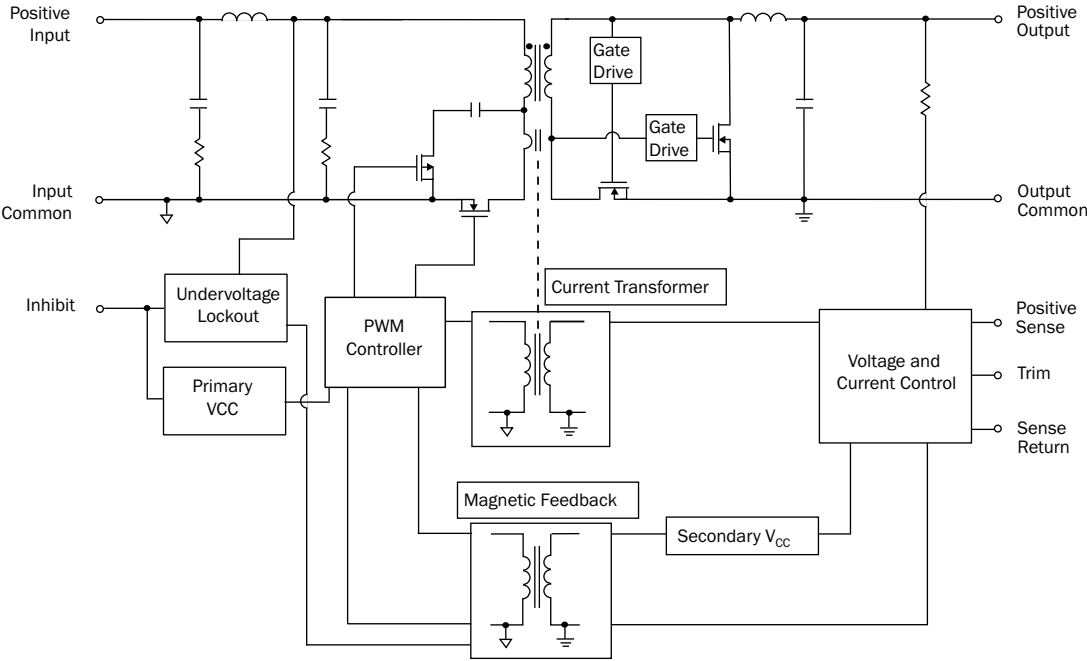

FIGURE 7: MFX SINGLE BLOCK DIAGRAM

# MFX Single Output DC-DC Converters

## 16 TO 50 VOLT INPUT - 50 WATT

### REMOTE SENSE

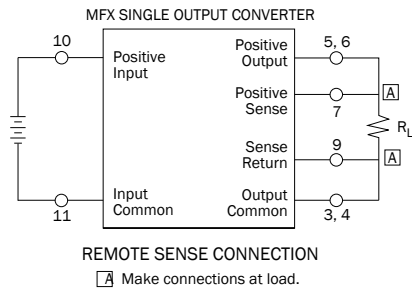

FIGURE 8: REMOTE SENSE CONNECTION

**CAUTION:** The converter will be permanently damaged if the positive sense (pin 7) is shorted to Output Common and not connected to Positive Output. Damage may also result if either the Output Common or Positive Output is disconnected from the load when the remote sense leads are connected to the load.

### TRIM

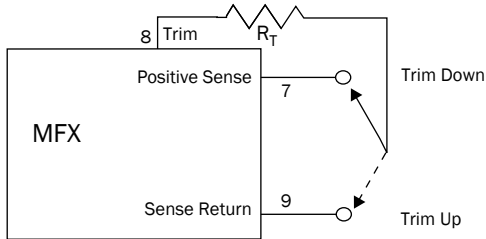

FIGURE 9: TRIM CONNECTION

Nominal $V_{OUT}$	Function	Trim Range	Formula <sup>1</sup>
3.3	Trim Down <sup>2</sup>	3.3 to 3.0	$R_T = \frac{-10.2}{V_O - 3.301} - 31$
	Trim Up <sup>3</sup>	3.3 to 3.6	$R_T = \frac{15.7}{V_O - 3.301} - 23.2$
5	Trim Down <sup>2</sup>	5.0 to 4.5	$R_T = \frac{-54.8}{V_O - 5.008} - 90$
	Trim Up <sup>3</sup>	5.0 to 5.5	$R_T = \frac{36.4}{V_O - 5.008} - 71.5$
9	Trim Down <sup>2</sup>	9.0 to 8.1	$R_T = \frac{-303}{V_O - 9.024} - 139$
	Trim Up <sup>3</sup>	9 to 9.9	$R_T = \frac{86.4}{V_O - 9.024} - 95.3$
12	Trim Down <sup>2</sup>	12 to 10.8	$R_T = \frac{-512}{V_O - 12.020} - 136$
	Trim Up <sup>3</sup>	12 to 13.2	$R_T = \frac{102.2}{V_O - 12.020} - 84.5$
15	Trim Down <sup>2</sup>	15 to 13.5	$R_T = \frac{-1212}{V_O - 15.021} - 214$
	Trim Up <sup>3</sup>	15 to 16.5	$R_T = \frac{186.2}{V_O - 15.021} - 121$
25° C, $V_O$ = desired output voltage, $R_T$ = trim resistor (kΩ)			

TABLE 1: TRIM FORMULAS

1. If the calculated value is negative, the desired output voltage is outside the allowed trim range.
2. When trimming down do not exceed the maximum output current.
3. When trimming up do not exceed the maximum output power.

# MFX Single Output DC-DC Converters

## 16 TO 50 VOLT INPUT - 50 WATT

PIN OUT	
Pin	Single Output
1	No connection
2	Case Ground
3	Output Common
4	Output Common
5	Positive Output
6	Positive Output
7	Positive Sense
8	Trim
9	Sense Return
10	Positive Input
11	Input Common
12	Inhibit

TABLE 2: PIN OUT

PINS NOT IN USE	
Inhibit	Leave unconnected
Positive Sense	Connect to Positive Output
Trim	Leave unconnected
Sense Return	Connect to Output Common

TABLE 3: PINS NOT IN USE

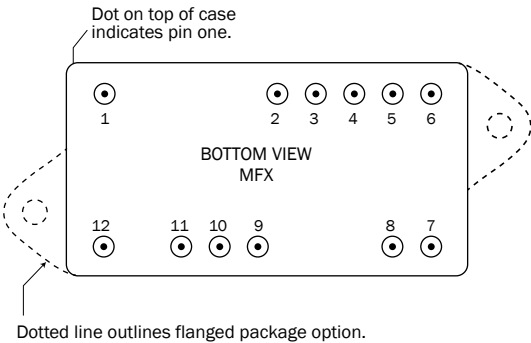

See Figure 38 on page 23 and  
Figure 39 on page 24 for dimensions.

FIGURE 10: MFX SINGLE PIN OUT

# MFX Single Output DC-DC Converters

## 16 TO 50 VOLT INPUT - 50 WATT

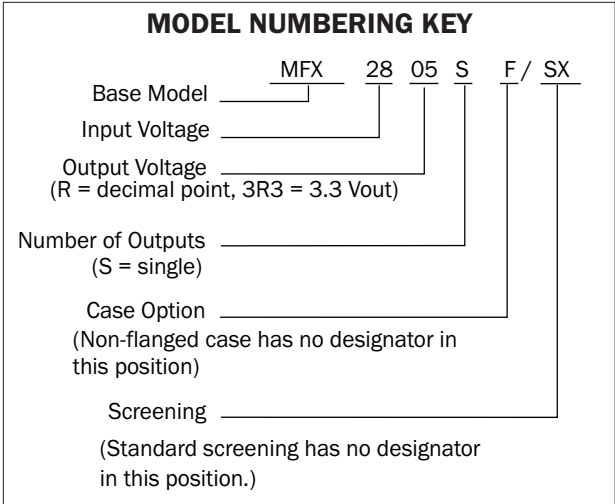

FIGURE 11: MODEL NUMBERING KEY

<b>MODEL NUMBER OPTIONS</b>					
TO DETERMINE THE MODEL NUMBER ENTER ONE OPTION FROM EACH CATEGORY IN THE FORM BELOW.					
CATEGORY	Base Model and Input Voltage	Output Voltage <sup>1</sup>	Number of Outputs <sup>2</sup>	Case Options <sup>3</sup>	Screening <sup>4</sup>
<b>OPTIONS</b>	MFX28	3R3, 05, 09, 12, 15	S	(non-flanged, leave blank) F (flanged)	(standard, leave blank) ES SX
<b>FILL IN FOR MODEL # <sup>5</sup></b>	MFX28	_____	_____	_____	/ _____
<p>Notes</p> <p>1. Output Voltage: An R indicates a decimal point. 3R3 is 3.3 volts out.</p> <p>2. Number of Outputs: S is a single output.</p> <p>3. Case Options: For the standard case, Figure 38 on page 23, leave the case option blank. For the flanged case option, Figure 39 on page 24, insert the letter F in the Case Option position</p> <p>4. Screening: For standard screening leave the screening option blank. For other screening options, insert the desired screening level. For more information see Table 1.1 on page 25.</p> <p>5. If ordering by model number add a "-Q" to request solder dipped leads (MFX2805S/SX-Q).</p>					

TABLE 4: MODEL NUMBER OPTIONS



# MFX Single Output DC-DC Converters

## 16 TO 50 VOLT INPUT - 50 WATT

TABLE 5: OPERATING CONDITIONS, ALL MODELS, 25 °C CASE, 28 VIN, 100% LOAD, UNLESS OTHERWISE SPECIFIED.

MFX SERIES		ALL MODELS			UNITS
PARAMETER	CONDITIONS	MIN	TYP	MAX	
LEAD SOLDERING TEMPERATURE <sup>1</sup>	10 SECONDS MAX.	–	–	300	°C
STORAGE TEMPERATURE <sup>1</sup>		-65	–	+150	°C
CASE OPERATING TEMPERATURE	FULL POWER	-55	–	+125	°C
	ABSOLUTE <sup>1</sup>	-55	–	+135	
DERATING OUTPUT POWER/CURRENT <sup>1</sup>	LINEARLY	From 100% at 125 °C to 0% at 135 °C			
ESD RATING <sup>1, 2</sup>	MIL-STD-883 METHOD 3015	2000 - 3999			V
MIL-PRF-38534, 3.9.5.8.2	CLASS 2				
ISOLATION: INPUT TO OUTPUT, INPUT TO CASE, OUTPUT TO CASE <sup>3</sup>	500 VDC AT 25 °C	100	–	–	Megohms
UNDERVOLTAGE LOCKOUT -55 °C TO +125 °C	RISING V <sub>IN</sub> (TURN ON)	13.3	15.3	15.9	V
	FALLING V <sub>IN</sub> (TURN OFF)	13.3	14.3	15.6	
CURRENT LIMIT <sup>4</sup>	% OF FULL LOAD	–	130	–	%
SWITCHING FREQUENCY	-55 °C TO +125 °C	455	500	545	kHz
INHIBIT ACTIVE LOW (OUTPUT DISABLED) Do not apply a voltage to the inhibit pin <sup>6</sup>	INHIBIT PIN PULLED LOW <sup>5</sup>	–	–	0.8	V
	INHIBIT PIN SOURCE CURRENT <sup>1</sup>	–	–	4	mA
	REFERENCED TO	INPUT COMMON			
INHIBIT ACTIVE HIGH (OUTPUT ENABLED) Do not apply a voltage to the inhibit pin <sup>6</sup>	INHIBIT PIN CONDITION	EXTERNAL OPEN COLLECTOR OR LEAVE UNCONNECTED			
	OPEN CIRCUIT PIN VOLTAGE <sup>1</sup>	14	16	18	V

For mean time between failures (MTBF) contact Applications Engineering at [powerapps@craneae.com](mailto:powerapps@craneae.com)

#### Notes

1. Guaranteed by characterization test and/or analysis. Not a production test.
2. Passed 2000 volts.
3. When testing isolation, input pins are tied together and output pins are tied together. They are tested against each other and against case. Discharge the pins before and after testing.
4. Current limit is defined as the point at which the output voltage drops by 1%.
5. Tested with inhibit pin connected to input common.
6. An external inhibit interface should be used to pull the inhibit low or leave it floating. The inhibit pin can be left unconnected if not used.

# MFX Single Output DC-DC Converters

## 16 TO 50 VOLT INPUT - 50 WATT

TABLE 6: ELECTRICAL CHARACTERISTICS -55 °C TO +125 °C CASE, 28 VIN, 100% LOAD, UNLESS OTHERWISE SPECIFIED.

SINGLE OUTPUT MODELS		MFX283R3S			MFX2805S			UNITS
PARAMETER	CONDITIONS	MIN	TYP	MAX	MIN	TYP	MAX	
OUTPUT VOLTAGE	T <sub>C</sub> = 25 °C	3.26	3.30	3.34	4.95	5.00	5.05	V
	T <sub>C</sub> = -55 °C TO +125 °C	3.20	3.30	3.40	4.85	5.00	5.15	
OUTPUT CURRENT	V <sub>IN</sub> = 16 TO 50	—	—	15.15	—	—	10	A
OUTPUT POWER	V <sub>IN</sub> = 16 TO 50	—	—	50	—	—	50	W
OUTPUT RIPPLE <sup>2</sup> 20 Hz - 10 MHz	T <sub>C</sub> = 25 °C	—	50	125	—	55	150	mV p-p
	T <sub>C</sub> = -55 °C TO +125 °C	—	55	125	—	60	150	
LINE REGULATION	V <sub>IN</sub> = 16 TO 50	—	0	15	—	0	15	mV
LOAD REGULATION	NO LOAD TO FULL	—	0	30	—	0	30	mV
INPUT VOLTAGE NO LOAD TO FULL	CONTINUOUS	16	28	50	16	28	50	V
	TRANSIENT <sup>1, 3</sup>	—	—	80	—	—	80	
INPUT CURRENT <sup>4</sup>	NO LOAD	—	60	140	—	75	140	mA
	INHIBITED	—	3	6	—	3	6	
INPUT RIPPLE CURRENT <sup>2</sup>	20 Hz - 10 MHz	—	60	150	—	50	150	mA p-p
EFFICIENCY	T <sub>C</sub> = 25 °C	85	89	—	87	91	—	%
	T <sub>C</sub> = -55 °C TO +125 °C	84	88	—	85	89	—	
LOAD FAULT <sup>5, 6</sup>	POWER DISSIPATION	—	9	16	—	6	16	W
SHORT CIRCUIT	RECOVERY	—	13	20	—	13	20	ms
STEP LOAD RESPONSE <sup>5, 7</sup> 50% - 100% - 50%	TRANSIENT	—	±120	±300	—	±90	±250	mV pk
	RECOVERY	—	125	300	—	225	350	us
STEP LINE RESPONSE <sup>1, 5, 8</sup> V <sub>IN</sub> = 16 - 50 -16	TRANSIENT	—	±50	±265	—	±80	±300	mV pk
	RECOVERY	—	130	350	—	180	350	μs
START-UP <sup>4, 5, 9</sup>	DELAY	—	17	25	—	17	25	ms
FULL LOAD	OVERSHOOT	—	0	30	—	0	50	mV pk
CAPACITIVE LOAD <sup>1, 10</sup>	T <sub>C</sub> = 25 °C	—	—	5000	—	—	5000	uF

#### Notes

- Guaranteed by characterization test and/or analysis. Not a production test.
- Although no minimum load is required, the converter may skip pulses at high line and light load (10% or less) to maintain output voltage regulation. The result is higher input ripple current and output ripple voltage that may exceed the specification.
- Up to 80 volt transient per MIL-STD-704 A.
- Following a shutdown event by assertion of the inhibit function, the assert to de-assert delay time must be made externally by at least 10 ms for no capacitive loading and 150 ms at maximum capacitive loading. The inhibit signal to the inhibit pin must also use debounce to prevent rapid turn-off and turn-on of the converter to prevent damage. See "Control" section on page 2-3 for more details.
- Recovery and startup times are measured from application of the transient or change in condition to the point at which V<sub>OUT</sub> is within 1% of final value.
- MFX design implements self-driven synchronous rectification with short-circuit protection. Continuous operation in the red area of the curve in Figure 6 on page 4 may damage or substantially shorten the life of the converter. See "Output Overload and Short-Circuit Protection" for more details.
- Step load step characterization is performed at 10 microseconds typical.
- Step line test is performed at 100 microseconds ±20 microseconds.
- Tested on release from inhibit.
- No effect on dc performance.

# MFX Single Output DC-DC Converters

## 16 TO 50 VOLT INPUT - 50 WATT

TABLE 7: ELECTRICAL CHARACTERISTICS -55 °C TO +125 °C CASE, 28 VIN, 100% LOAD, UNLESS OTHERWISE SPECIFIED.

SINGLE OUTPUT MODELS		MFX2809S			MFX2812S			MFX2815S			UNITS
PARAMETER	CONDITIONS	MIN	TYP	MAX	MIN	TYP	MAX	MIN	TYP	MAX	
OUTPUT VOLTAGE	T <sub>C</sub> = 25 °C	8.91	9.00	9.09	11.88	12.00	12.12	14.85	15.00	15.15	V
	T <sub>C</sub> = -55 °C TO +125 °C	8.73	9.00	9.27	11.64	12.00	12.36	14.55	15.00	15.45	
OUTPUT CURRENT	V <sub>IN</sub> = 16 TO 50	—	—	5.56	—	—	4.17	—	—	3.33	A
OUTPUT POWER	V <sub>IN</sub> = 16 TO 50	—	—	50	—	—	50	—	—	50	W
OUTPUT RIPPLE <sup>2</sup> 20 Hz - 10 MHz	T <sub>C</sub> = 25 °C	—	—	150	—	—	150	—	—	150	mV p-p
	T <sub>C</sub> = -55 °C TO +125 °C	—	—	150	—	—	150	—	—	150	
LINE REGULATION	V <sub>IN</sub> = 16 TO 50	—	—	15	—	—	15	—	—	15	mV
LOAD REGULATION	NO LOAD TO FULL	—	—	30	—	—	30	—	—	30	mV
INPUT VOLTAGE NO LOAD TO FULL	CONTINUOUS	16	28	50	16	28	50	16	28	50	V
	TRANSIENT <sup>1, 3, 4</sup>	—	—	80	—	—	80	—	—	80	
INPUT CURRENT <sup>5</sup>	NO LOAD	—	—	140	—	—	140	—	—	140	mA
	INHIBITED	—	—	6	—	—	6	—	—	6	
INPUT RIPPLE CURRENT <sup>2</sup>	20 Hz - 10 MHz	—	—	150	—	—	150	—	—	150	mA p-p
EFFICIENCY	T <sub>C</sub> = 25 °C	88	92	—	89	93	—	89	93	—	%
	T <sub>C</sub> = -55 °C TO +125 °C	87	91	—	88	92	—	88	92	—	
LOAD FAULT <sup>6, 7</sup>	POWER DISSIPATION	—	—	10	—	—	10	—	—	10	W
SHORT CIRCUIT	RECOVERY	—	—	15	—	—	15	—	—	15	ms
STEP LOAD RESPONSE <sup>6, 8</sup> 50% - 100% - 50%	TRANSIENT	—	—	±650	—	—	±650	—	—	±650	mV pk
	RECOVERY	—	—	500	—	—	500	—	—	500	us
STEP LINE RESPONSE <sup>1, 6, 9</sup> V <sub>IN</sub> = 16 - 50 - 16	TRANSIENT	—	—	±540	—	—	±720	—	—	±900	mV pk
	RECOVERY	—	—	500	—	—	500	—	—	500	μs
START-UP <sup>4, 6, 10</sup>	DELAY	—	—	20	—	—	20	—	—	20	ms
FULL LOAD	OVERSHOOT	—	—	50	—	—	50	—	—	50	mV pk
CAPACITIVE LOAD <sup>1, 11</sup>	T <sub>C</sub> = 25 °C	—	—	2000	—	—	2000	—	—	2000	uF

### Notes

1. Guaranteed by characterization test and/or analysis. Not a production test.
2. Although no minimum load is required, the converter may skip pulses at high line and light load (10% or less) to maintain output voltage regulation. The result is higher input ripple current and output ripple voltage that may exceed the specification.
3. Up to 80 volt transient per MIL-STD-704 A.
4. For the 9, 12, and 15 volt models, the output ripple voltage may exceed the steady-state specifications during an 80 volt transient. In higher output loading conditions, the output voltage for these models may momentarily drop (typically 1-2 volts) below the nominal regulation during the 80 volt transient. The converters will resume regulation when the input voltage returns to the rated continuous range.
5. Following a shutdown event by assertion of the inhibit function, the assert to de-assert delay time must be made externally by at least 10 ms for no capacitive loading and 150 ms at maximum capacitive loading. The inhibit signal to the inhibit pin must also use debounce to prevent rapid turn-off and turn-on of the converter to prevent damage. See "Control" section on page 2-3 for more details.
6. Recovery and startup times are measured from application of the transient or change in condition to the point at which V<sub>OUT</sub> is within 1% of final value.
7. MFX design implements self-driven synchronous rectification with short-circuit protection. Continuous operation in the red area of the curve in Figure 6 on page 4 may damage or substantially shorten the life of the converter. See "Output Overload and Short-Circuit Protection" for more details.
8. Step load step characterization is performed at 10 microseconds typical.
9. Step line test is performed at 100 microseconds ±20 microseconds.
10. Tested on release from inhibit.
11. No effect on dc performance.

# MFX Single Output DC-DC Converters

## 16 TO 50 VOLT INPUT - 50 WATT

TABLE 8: OPERATING CONDITIONS, ALL MODELS, 25 °C CASE, 42 VIN, 100% LOAD, UNLESS OTHERWISE SPECIFIED.

MFX SERIES PARAMETER <sup>1</sup>	CONDITIONS	ALL MODELS			UNITS
		MIN	TYP	MAX	
LEAD SOLDERING TEMPERATURE <sup>1</sup>	10 SECONDS MAX.	–	–	300	°C
STORAGE TEMPERATURE <sup>1</sup>		-65	–	+150	°C
CASE OPERATING TEMPERATURE	FULL POWER	-55	–	+125	°C
	ABSOLUTE <sup>1</sup>	-55	–	+135	
DERATING OUTPUT POWER/CURRENT <sup>1</sup>	LINEARLY	From 100% at 125 °C to 0% at 135 °C			
ESD RATING <sup>1, 2</sup> MIL-PRF-38534, 3.9.5.8.2	MIL-STD-883 METHOD 3015 CLASS 2	2000 - 3999 <sup>2</sup>			V
ISOLATION: INPUT TO OUTPUT, INPUT TO CASE, OUTPUT TO CASE <sup>3</sup>	500 VDC AT 25 °C	100	–	–	Megohms
UNDERVOLTAGE LOCKOUT -55 °C TO +125 °C	RISING V <sub>IN</sub> (TURN ON)	13.3	15.3	15.9	V
	FALLING V <sub>IN</sub> (TURN OFF)	13.3	14.3	15.6	
CURRENT LIMIT <sup>4</sup>	% OF FULL LOAD	–	130	–	%
SWITCHING FREQUENCY	-55 °C TO +125 °C	455	500	545	kHz
INHIBIT ACTIVE LOW (OUTPUT DISABLED) Do not apply a voltage to the inhibit pin <sup>6</sup>	INHIBIT PIN PULLED LOW <sup>5</sup>	–	–	0.8	V
	INHIBIT PIN SOURCE CURRENT <sup>1</sup>	–	–	4	mA
	REFERENCED TO	INPUT COMMON			
INHIBIT ACTIVE HIGH (OUTPUT ENABLED) Do not apply a voltage to the inhibit pin <sup>6</sup>	INHIBIT PIN CONDITION	EXTERNAL OPEN COLLECTOR OR LEAVE UNCONNECTED			
	OPEN CIRCUIT PIN VOLTAGE <sup>1</sup>	14	16	18	V

For mean time between failures (MTBF) contact Applications Engineering at [powerapps@craneae.com](mailto:powerapps@craneae.com)

## Notes

1. Guaranteed by characterization test and/or analysis. Not a production test.
2. Passed 2000 volts.
3. When testing isolation, input pins are tied together and output pins are tied together. They are tested against each other and against case. Discharge the pins before and after testing.
4. Current limit is defined as the point at which the output voltage drops by 1%.

5. Tested with inhibit pin connected to input common.
6. An external inhibit interface should be used to pull the inhibit low or leave it floating. The inhibit pin can be left unconnected if not used.

# MFX Single Output DC-DC Converters

## 16 TO 50 VOLT INPUT - 50 WATT

TABLE 9: ELECTRICAL CHARACTERISTICS -55 °C TO +125 °C CASE, 42 VIN, 100% LOAD, UNLESS OTHERWISE SPECIFIED.

SINGLE OUTPUT MODELS		MFX283R3S			MFX2805S			UNITS
PARAMETER <sup>1</sup>	CONDITIONS	MIN	TYP	MAX	MIN	TYP	MAX	
OUTPUT VOLTAGE	T <sub>C</sub> = 25 °C	3.26	3.30	3.34	4.95	5.00	5.05	V
	T <sub>C</sub> = -55 °C TO +125 °C	3.20	3.30	3.40	4.85	5.00	5.15	
OUTPUT CURRENT	V <sub>IN</sub> = 16 TO 50	—	—	15.15	—	—	10	A
OUTPUT POWER	V <sub>IN</sub> = 16 TO 50	—	—	50	—	—	50	W
OUTPUT RIPPLE <sup>2</sup> 20 Hz - 10 MHz	T <sub>C</sub> = 25 °C	—	75	125	—	75	150	mV p-p
	T <sub>C</sub> = -55 °C TO +125 °C	—	75	125	—	75	150	
LINE REGULATION	V <sub>IN</sub> = 16 TO 50	—	1	15	—	1	15	mV
LOAD REGULATION	NO LOAD TO FULL	—	2	30	—	2	30	mV
INPUT VOLTAGE NO LOAD TO FULL	CONTINUOUS	16	42	50	16	42	50	V
	TRANSIENT <sup>1, 3</sup>	—	—	80	—	—	80	
INPUT CURRENT <sup>4</sup>	NO LOAD	—	60	140	—	75	140	mA
	INHIBITED	—	3	6	—	3	6	
INPUT RIPPLE CURRENT <sup>2</sup>	20 Hz - 10 MHz	—	50	150	—	50	150	mA p-p
EFFICIENCY	T <sub>C</sub> = 25 °C	84	88	—	85	89	—	%
	T <sub>C</sub> = -55 °C TO +125 °C	83	87	—	83	87	—	
LOAD FAULT <sup>5, 6</sup>	POWER DISSIPATION	—	10	17	—	7	17	W
SHORT CIRCUIT	RECOVERY	—	13	20	—	13	20	ms
STEP LOAD RESPONSE <sup>5, 7</sup> 50% - 100% - 50%	TRANSIENT	—	±120	±300	—	±90	±250	mV pk
	RECOVERY	—	150	300	—	225	350	us
STEP LINE RESPONSE <sup>1, 5, 8</sup> V <sub>IN</sub> = 16 - 50 - 16	TRANSIENT	—	±50	±265	—	±80	±300	mV pk
	RECOVERY	—	130	350	—	180	350	μs
START-UP <sup>4, 5, 9</sup>	DELAY	—	17	25	—	17	25	ms
FULL LOAD	OVERSHOOT	—	0	30	—	0	50	mV pk
CAPACITIVE LOAD <sup>1, 10</sup>	T <sub>C</sub> = 25 °C	—	—	5000	—	—	5000	uF

## Notes

- Guaranteed by characterization test and/or analysis. Not a production test.
- Although no minimum load is required, the converter may skip pulses at high line and light load (10% or less) to maintain output voltage regulation. The result is higher input ripple current and output ripple voltage that may exceed the specification.
- Up to 80 volt transient per MIL-STD-704 A.
- Following a shutdown event by assertion of the inhibit function, the assert to de-assert delay time must be made externally by at least 10 ms for no capacitive loading and 150 ms at maximum capacitive loading. The inhibit signal to the inhibit pin must also use debounce to prevent rapid turn-off and turn-on of the converter to prevent damage. See "Control" section on page 2-3 for more details.
- Recovery and startup times are measured from application of the transient or change in condition to the point at which V<sub>OUT</sub> is within 1% of final value.
- MFX design implements self-driven synchronous rectification with short-circuit protection. Continuous operation in the red area of the curve in Figure 6 on page 4 may damage or substantially shorten the life of the converter. See "Output Overload and Short-Circuit Protection" for more details.
- Step load step characterization is performed at 10 microseconds typical.
- Step line test is performed at 100 microseconds ±20 microseconds.
- Tested on release from inhibit.
- No effect on dc performance.

# MFX Single Output DC-DC Converters

## 16 TO 50 VOLT INPUT - 50 WATT

TABLE 10: ELECTRICAL CHARACTERISTICS -55 °C TO +125 °C CASE, 42 VIN, 100% LOAD, UNLESS OTHERWISE SPECIFIED.

SINGLE OUTPUT MODELS		MFX2809S			MFX2812S			MFX2815S			UNITS
PARAMETER <sup>1</sup>	CONDITIONS	MIN	TYP	MAX	MIN	TYP	MAX	MIN	TYP	MAX	
OUTPUT VOLTAGE	T <sub>C</sub> = 25 °C	8.91	9.00	9.09	11.88	12.00	12.12	14.85	15.00	15.15	V
	T <sub>C</sub> = -55 °C TO +125 °C	8.73	9.00	9.27	11.64	12.00	12.36	14.55	15.00	15.45	
OUTPUT CURRENT	V <sub>IN</sub> = 16 TO 50	—	—	5.56	—	—	4.17	—	—	3.33	A
OUTPUT POWER	V <sub>IN</sub> = 16 TO 5	—	—	50	—	—	50	—	—	50	W
OUTPUT RIPPLE <sup>2</sup> 20 Hz - 10 MHz	T <sub>C</sub> = 25 °C	—	—	150	—	—	150	—	—	150	mV p-p
	T <sub>C</sub> = -55 °C TO +125 °C	—	—	150	—	—	150	—	—	150	
LINE REGULATION	V <sub>IN</sub> = 16 TO 50	—	—	15	—	—	15	—	—	15	mV
LOAD REGULATION	NO LOAD TO FULL	—	—	30	—	—	30	—	—	30	mV
INPUT VOLTAGE NO LOAD TO FULL	CONTINUOUS	16	42	50	16	42	50	16	42	50	V
	TRANSIENT <sup>1, 3, 4</sup>	—	—	80	—	—	80	—	—	80	
INPUT CURRENT <sup>5</sup>	NO LOAD	—	—	140	—	—	140	—	—	140	mA
	INHIBITED	—	—	6	—	—	6	—	—	6	
INPUT RIPPLE CURRENT <sup>2</sup>	20 Hz - 10 MHz	—	—	150	—	—	150	—	—	150	mA p-p
EFFICIENCY	T <sub>C</sub> = 25 °C	86	90	—	87	91	—	87	91	—	%
	T <sub>C</sub> = -55 °C TO +125 °C	85	89	—	86	90	—	86	90	—	
LOAD FAULT <sup>6, 7</sup>	POWER DISSIPATION	—	—	16	—	—	16	—	—	16	W
SHORT CIRCUIT	RECOVERY	—	—	15	—	—	15	—	—	15	ms
STEP LOAD RESPONSE <sup>6, 8</sup> 50% - 100% - 50%	TRANSIENT	—	—	±650	—	—	±650	—	—	±650	mV pk
	RECOVERY	—	—	500	—	—	500	—	—	500	us
STEP LINE RESPONSE <sup>1, 6, 9</sup> V <sub>IN</sub> = 16 - 50 - 16	TRANSIENT	—	—	±540	—	—	±720	—	—	±900	mV pk
	RECOVERY	—	—	500	—	—	500	—	—	500	μs
START-UP <sup>4, 6, 10</sup>	DELAY	—	—	20	—	—	20	—	—	20	ms
FULL LOAD	OVERSHOOT	—	—	50	—	—	50	—	—	50	mV pk
CAPACITIVE LOAD <sup>1, 11</sup>	T <sub>C</sub> = 25 °C	—	—	2000	—	—	2000	—	—	2000	uF

## Notes

- Guaranteed by characterization test and/or analysis. Not a production test.
- Although no minimum load is required, the converter may skip pulses at high line and light load (10% or less) to maintain output voltage regulation. The result is higher input ripple current and output ripple voltage that may exceed the specification.
- Up to 80 volt transient per MIL-STD-704 A.
- For the 9, 12, and 15 volt models, the output ripple voltage may exceed the steady-state specifications during an 80 volt transient. In higher output loading conditions, the output voltage for these models may momentarily drop (typically 1-2 volts) below the nominal regulation during the 80 volt transient. The converters will resume regulation when the input voltage returns to the rated continuous range.
- Following a shutdown event by assertion of the inhibit function, the assert to de-assert delay time must be made externally by at least 10 ms for no capacitive loading and 150 ms at maximum capacitive loading. The inhibit signal to the inhibit pin must also use debounce to prevent rapid turn-off and turn-on of the converter to prevent damage. See "Control" section on page 2-3 for more details.
- Recovery and startup times are measured from application of the transient or change in condition to the point at which V<sub>OUT</sub> is within 1% of final value.
- MFX design implements self-driven synchronous rectification with short-circuit protection. Continuous operation in the red area of the curve in Figure 6 on page 4 may damage or substantially shorten the life of the converter. See "Output Overload and Short-Circuit Protection" for more details.
- Step load step characterization is performed at 10 microseconds typical.
- Step line test is performed at 100 microseconds ±20 microseconds.
- Tested on release from inhibit.
- No effect on dc performance.

# MFX Single Output DC-DC Converters

## 16 TO 50 VOLT INPUT - 50 WATT

TYPICAL PERFORMANCE PLOTS: 25 °C CASE, 28 VIN, 100% LOAD, FREE RUN, UNLESS OTHERWISE SPECIFIED.  
THESE ARE EXAMPLES FOR REFERENCE ONLY AND ARE NOT GUARANTEED SPECIFICATIONS.

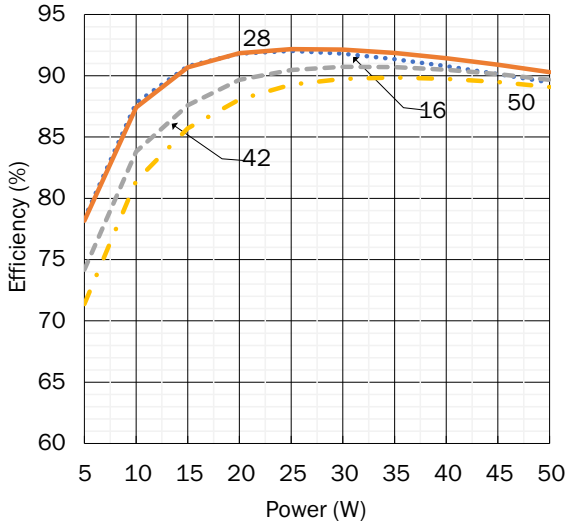

MFX283R3S EFFICIENCY  
FIGURE 12

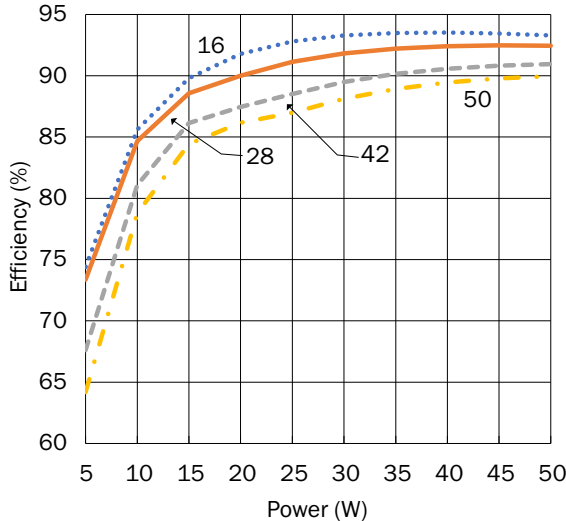

MFX2805S EFFICIENCY  
FIGURE 13

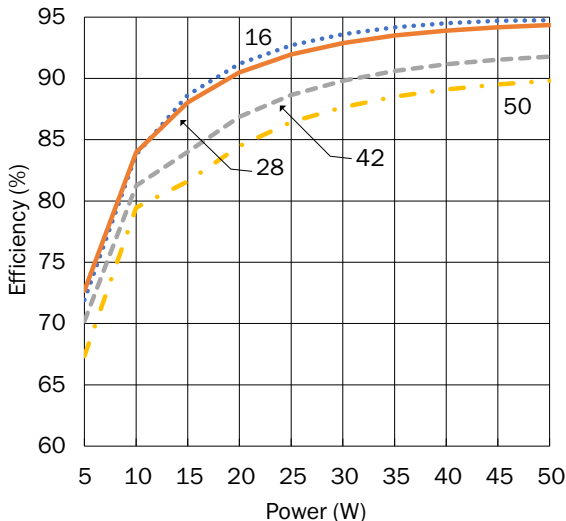

MFX2809S EFFICIENCY  
FIGURE 14

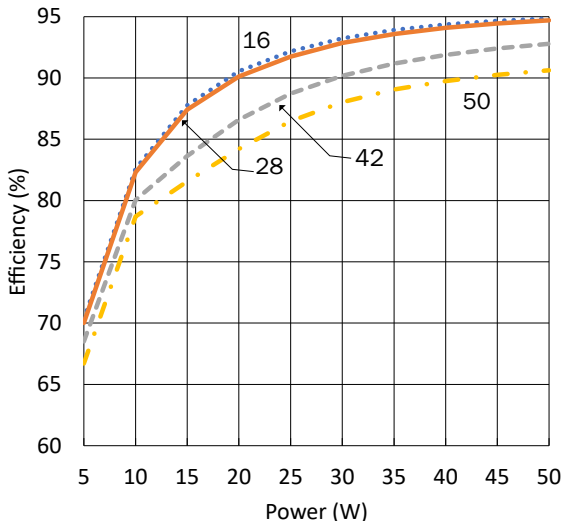

MFX2812S EFFICIENCY  
FIGURE 15

# MFX Single Output DC-DC Converters

## 16 TO 50 VOLT INPUT - 50 WATT

TYPICAL PERFORMANCE PLOTS: 25°C CASE, 28 VIN, 100% LOAD, FREE RUN, UNLESS OTHERWISE SPECIFIED.  
THESE ARE EXAMPLES FOR REFERENCE ONLY AND ARE NOT GUARANTEED SPECIFICATIONS.

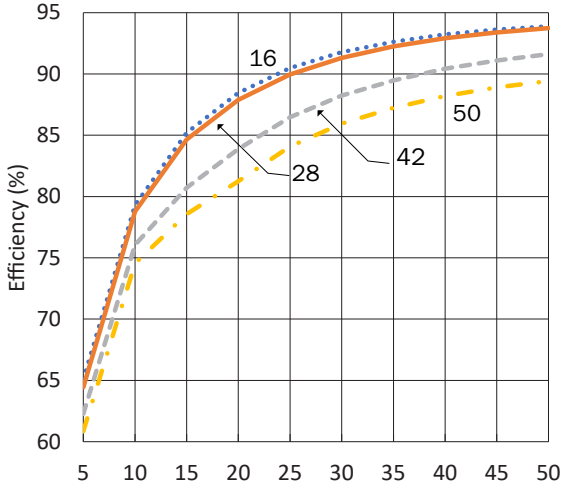

MFX2815S EFFICIENCY  
FIGURE 16

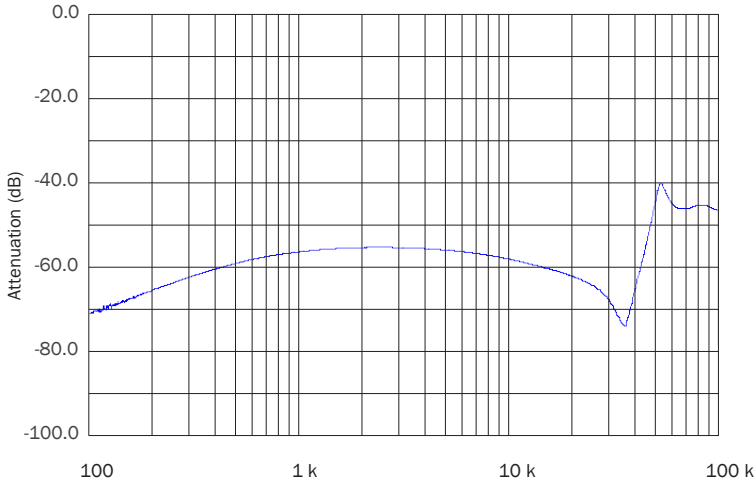

MFX2805S AUDIO REJECTION  
FIGURE 17

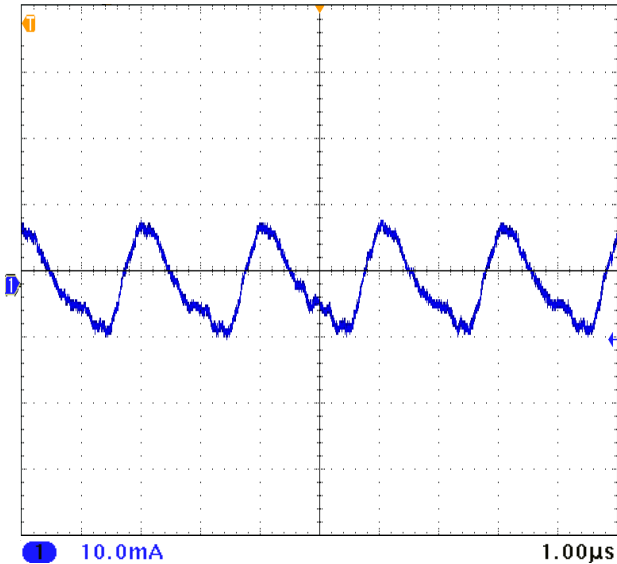

BW 20 Hz - 20 MHz UNITS ARE PER DIVISION  
MFX2805S INPUT RIPPLE

FIGURE 18

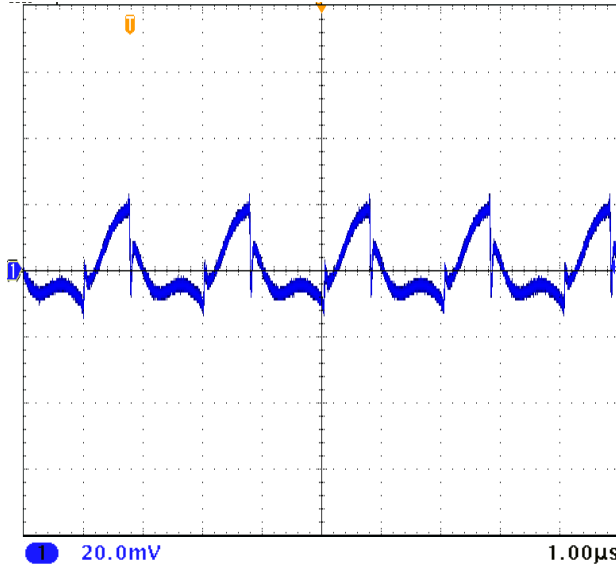

BW 20 Hz - 20 MHz UNITS ARE PER DIVISION  
MFX2805S OUTPUT RIPPLE

FIGURE 19



# MFX Single Output DC-DC Converters

## 16 TO 50 VOLT INPUT - 50 WATT

TYPICAL PERFORMANCE PLOTS: 25°C CASE, 28 VIN, 100% LOAD, FREE RUN, UNLESS OTHERWISE SPECIFIED.  
THESE ARE EXAMPLES FOR REFERENCE ONLY AND ARE NOT GUARANTEED SPECIFICATIONS.

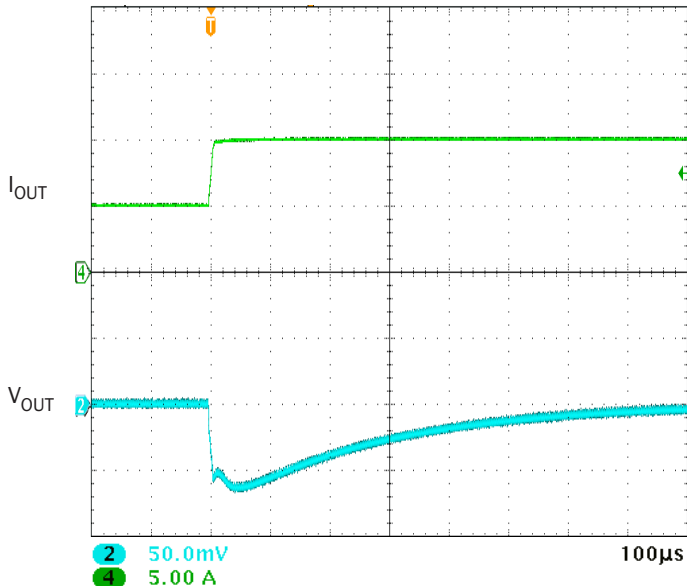

UNITS ARE PER DIVISION

MFX2805S STEP LOAD 50% - 100%  
FIGURE 20

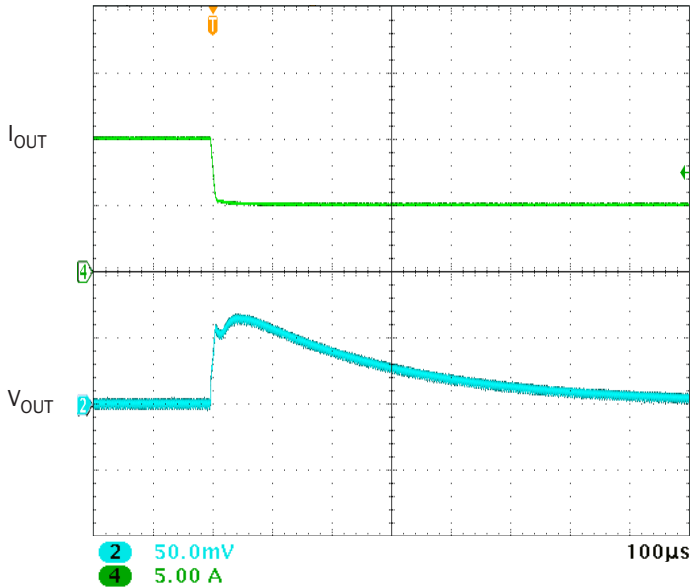

UNITS ARE PER DIVISION

MFX2805S STEP LOAD 100% - 50%  
FIGURE 21

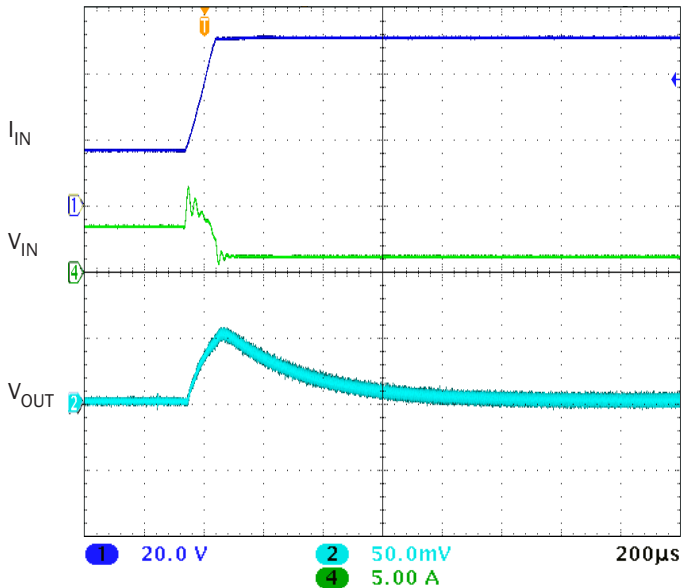

UNITS ARE PER DIVISION

MFX2805S STEP LINE 16 - 50 VOLTS 50% LOAD  
FIGURE 22

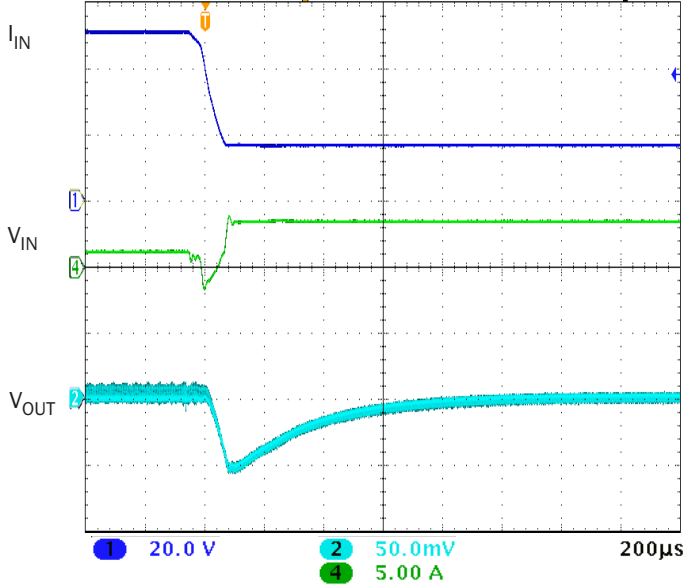

UNITS ARE PER DIVISION

MFX2805S STEP LINE 50 - 16 VOLTS 50% LOAD  
FIGURE 23

# MFX Single Output DC-DC Converters

## 16 TO 50 VOLT INPUT - 50 WATT

TYPICAL PERFORMANCE PLOTS: 25 °C CASE, 28 VIN, 100% LOAD, FREE RUN, UNLESS OTHERWISE SPECIFIED.  
THESE ARE EXAMPLES FOR REFERENCE ONLY AND ARE NOT GUARANTEED SPECIFICATIONS.

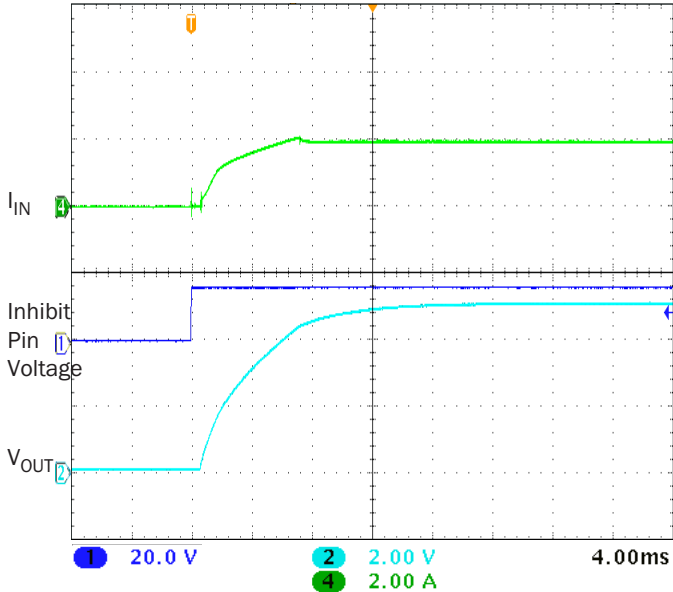

UNITS ARE PER DIVISION  
MFX2805S START-UP FULL LOAD  
FIGURE 24

# MFX Single Output DC-DC Converters

## 16 TO 50 VOLT INPUT - 50 WATT

TYPICAL PERFORMANCE PLOTS: 25 °C CASE, 42 VIN, 100% LOAD, UNLESS OTHERWISE SPECIFIED.  
FOR REFERENCE ONLY, NOT GUARANTEED SPECIFICATIONS.

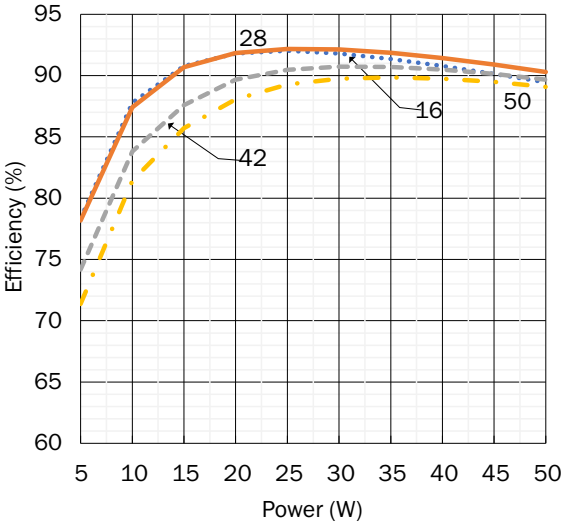

MFX283R3S EFFICIENCY  
FIGURE 25

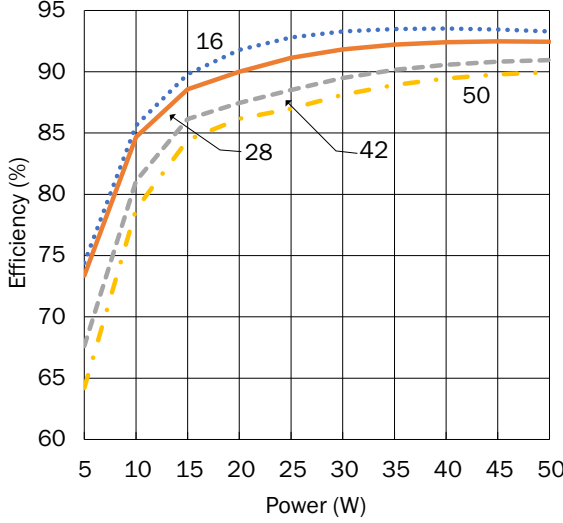

MFX2805S EFFICIENCY  
FIGURE 26

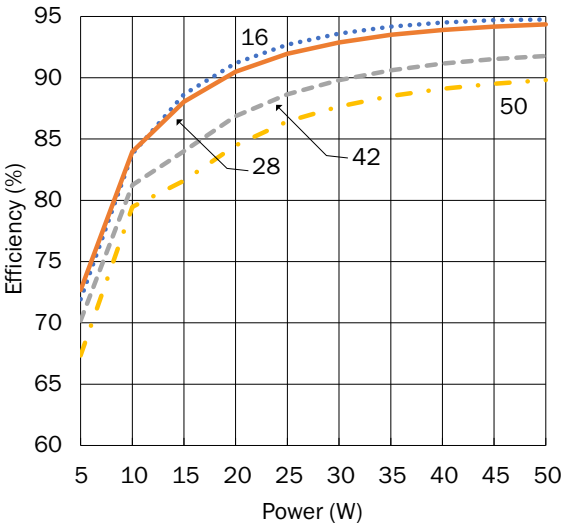

MFX2809S EFFICIENCY  
FIGURE 27

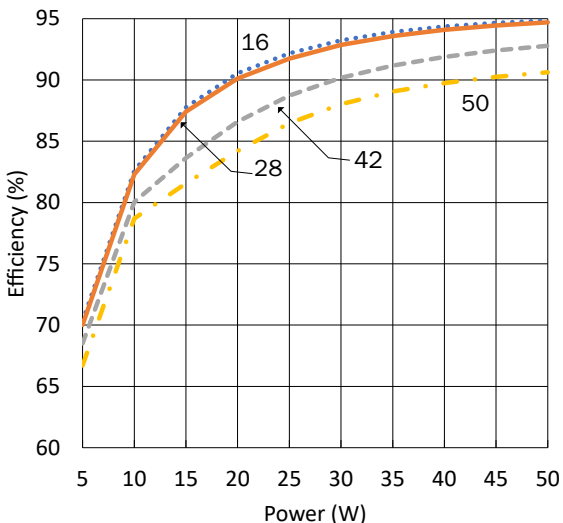

MFX2812S EFFICIENCY  
FIGURE 28

# MFX Single Output DC-DC Converters

## 16 TO 50 VOLT INPUT - 50 WATT

TYPICAL PERFORMANCE PLOTS: 25 °C CASE, 42 VIN, 100% LOAD, UNLESS OTHERWISE SPECIFIED.  
FOR REFERENCE ONLY, NOT GUARANTEED SPECIFICATIONS.

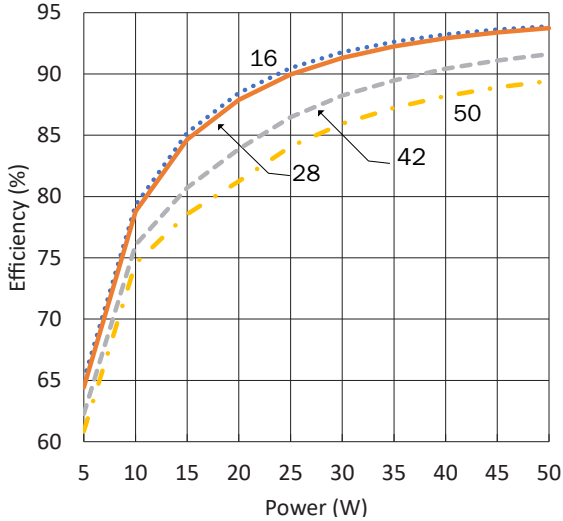

MFX2815S EFFICIENCY

FIGURE 29

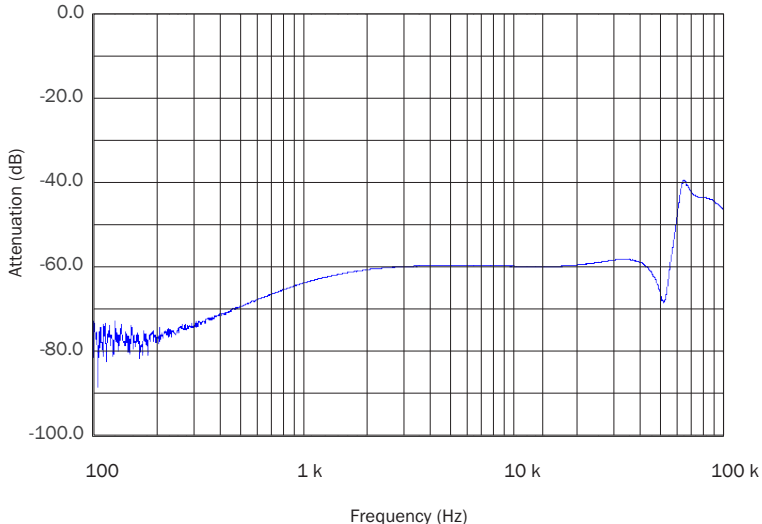

MFX2805S AUDIO REJECTION

FIGURE 30

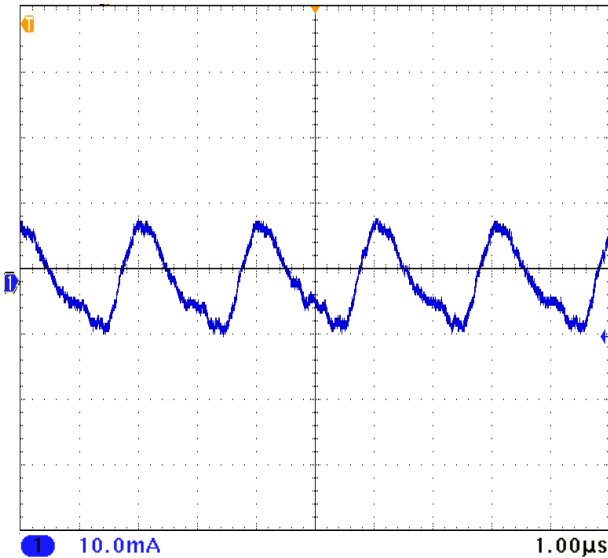

BW 20 Hz - 20 MHz UNITS ARE PER DIVISION

MFX2805S INPUT RIPPLE

FIGURE 31

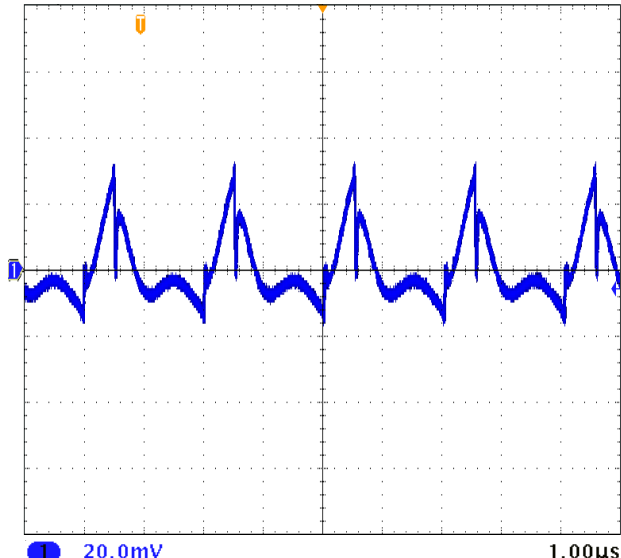

BW 20 Hz - 20 MHz UNITS ARE PER DIVISION

MFX2805S OUTPUT RIPPLE

FIGURE 32

# MFX Single Output DC-DC Converters

## 16 TO 50 VOLT INPUT - 50 WATT

TYPICAL PERFORMANCE PLOTS: 25 °C CASE, 42 VIN, 100% LOAD, UNLESS OTHERWISE SPECIFIED.  
FOR REFERENCE ONLY, NOT GUARANTEED SPECIFICATIONS.

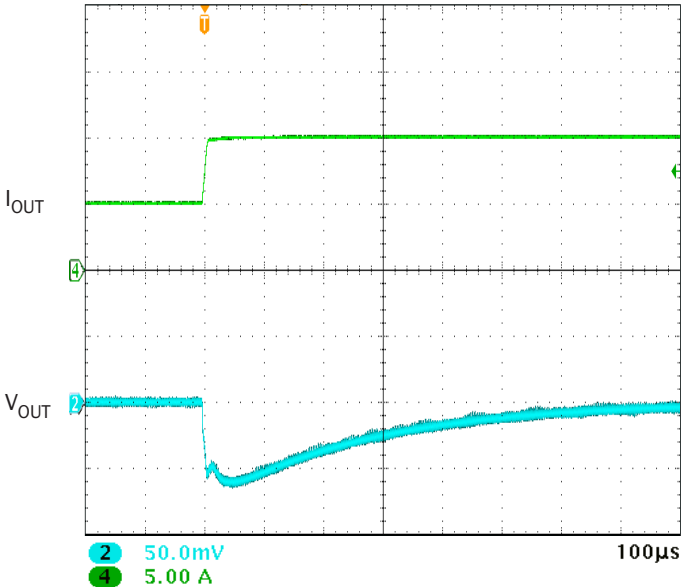

UNITS ARE PER DIVISION  
MFX2805S STEP LOAD 50% - 100%  
FIGURE 33

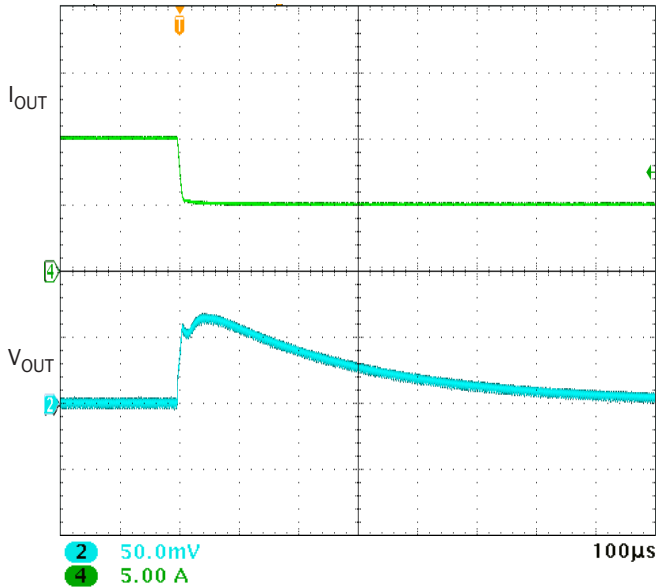

UNITS ARE PER DIVISION  
MFX2805S STEP LOAD 100% - 50%  
FIGURE 34

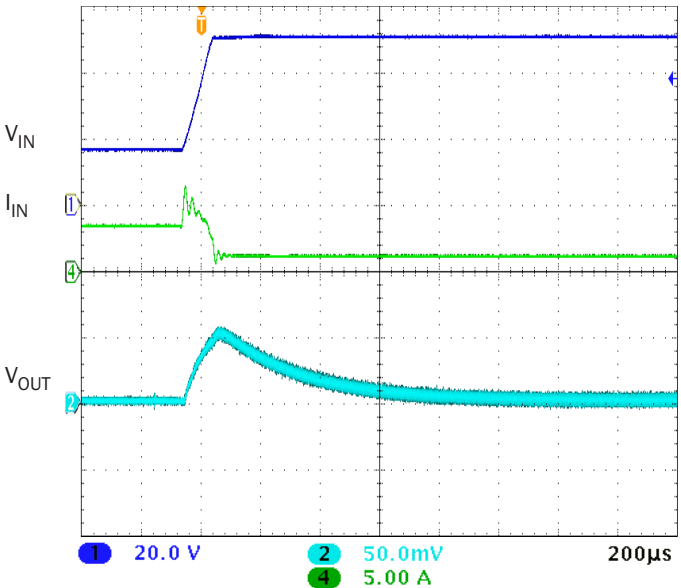

UNITS ARE PER DIVISION  
MFX2805S STEP LINE 16 - 50 VOLTS 50% LOAD  
FIGURE 35

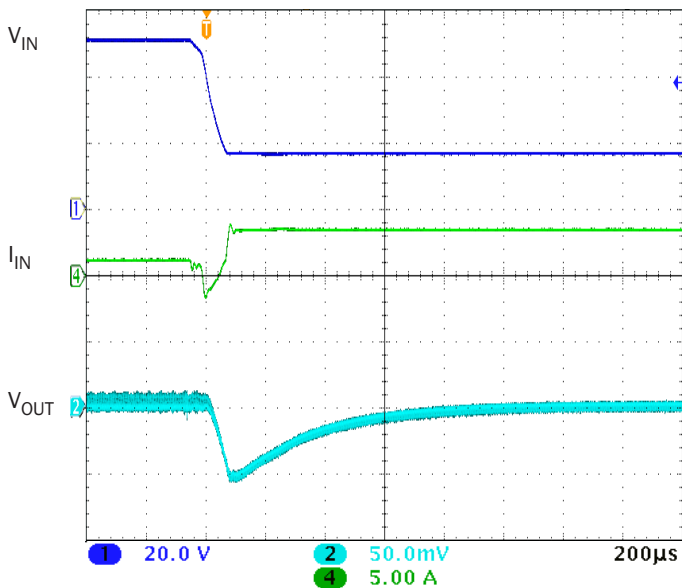

UNITS ARE PER DIVISION  
MFX2805S STEP LINE 50 - 16 VOLTS 50% LOAD  
FIGURE 36

# MFX Single Output DC-DC Converters

## 16 TO 50 VOLT INPUT - 50 WATT

TYPICAL PERFORMANCE PLOTS: 25 °C CASE, 42 VIN, 100% LOAD, UNLESS OTHERWISE SPECIFIED.  
FOR REFERENCE ONLY, NOT GUARANTEED SPECIFICATIONS.

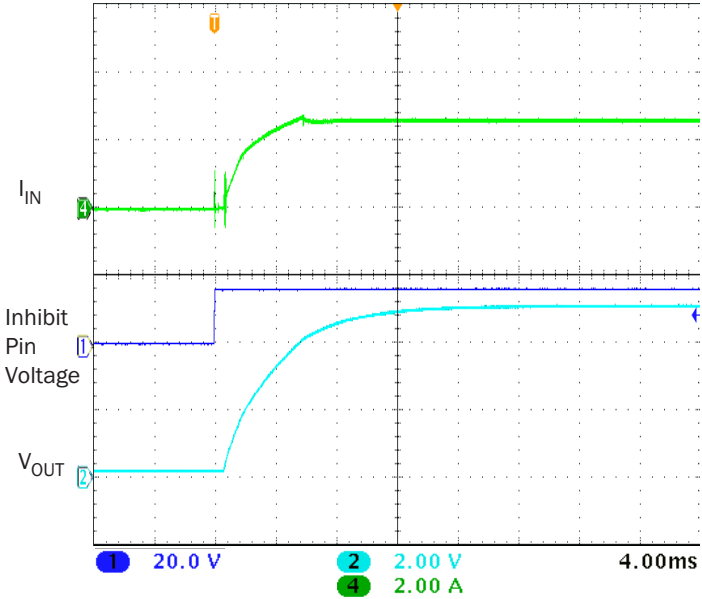

UNITS ARE PER DIVISION

MFX2805S START-UP FULL LOAD

FIGURE 37

# MFX Single Output DC-DC Converters

## 16 TO 50 VOLT INPUT - 50 WATT

BOTTOM VIEW MFX

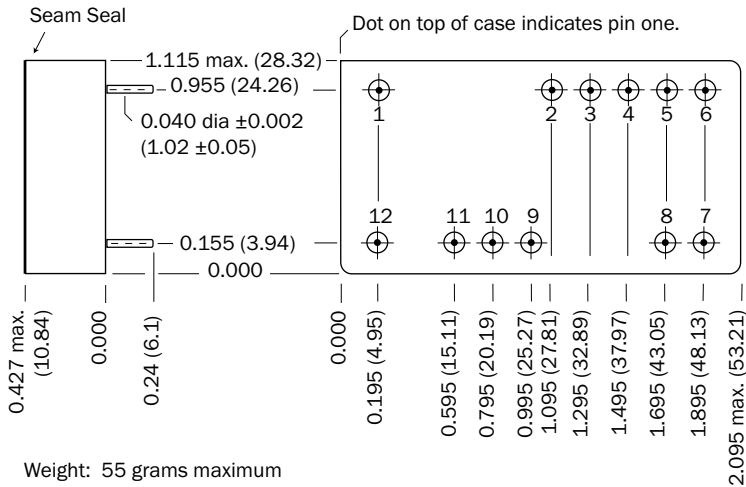

Weight: 55 grams maximum

Case dimensions in inches (mm)  
 Tolerance  $\pm 0.005$  (0.13) for three decimal places  
 $\pm 0.01$  (0.3) for two decimal places  
 unless otherwise specified

**CAUTION**  
 Heat from reflow or wave soldering may damage the device.  
 Solder pins individually with heat application not exceeding  
 300 °C for 10 seconds per pin.

**Materials**  
 Header Cold Rolled Steel/Nickel/Gold  
 Cover Kovar/Nickel  
 Pins #52 alloy/Gold glass compression seal  
 Gold plating of 50 - 150 microinches included in pin diameter  
 Seal hole  $0.092 \pm 0.002$  (3.05  $\pm$  0.05)

Please refer to the numerical dimensions for accuracy.

FIGURE 38: MFX

# MFX Single Output DC-DC Converters

## 16 TO 50 VOLT INPUT - 50 WATT

### BOTTOM VIEW MFX FLANGED

Flanged cases: Designator "F" required in Case Option position of model number

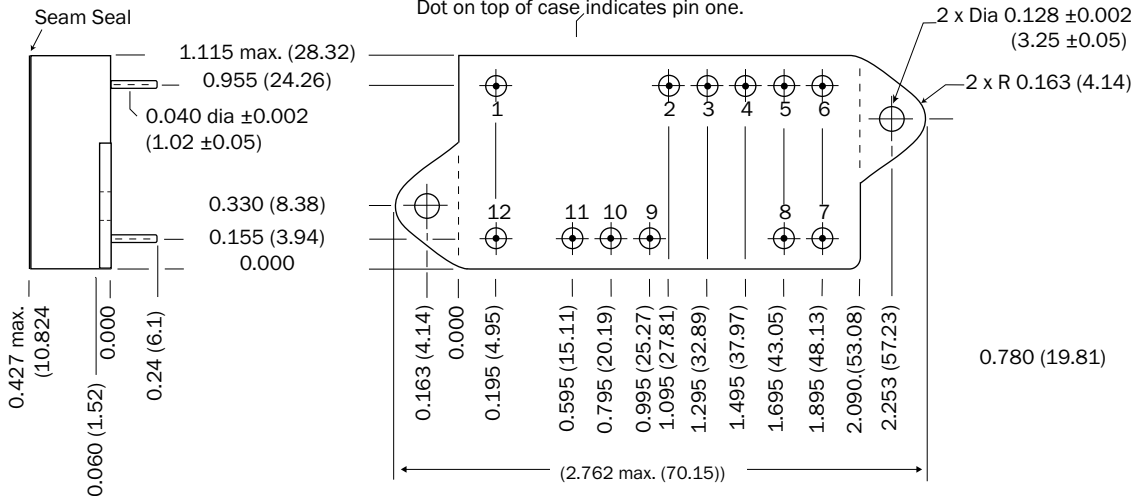

Weight: 55 grams maximum

Case dimensions in inches (mm)  
Tolerance ±0.005 (0.13) for three decimal places  
±0.01 (0.3) for two decimal places  
unless otherwise specified

**CAUTION**  
Heat from reflow or wave soldering may damage the device.  
Solder pins individually with heat application not exceeding 300 °C for 10 seconds per pin.

**Materials**  
Header Cold Rolled Steel/Nickel/Gold  
Cover Kovar/Nickel  
Pins #52 alloy/Gold glass compression seal  
Gold plating of 50 - 150 microinches included in pin diameter  
Seal hole 0.092 ±0.002 (3.05 ± 0.05)

Please refer to the numerical dimensions for accuracy.

FIGURE 39: MFX FLANGED



# MFX Single Output DC-DC Converters

**16 TO 50 VOLT INPUT - 50 WATT**

## ENVIRONMENTAL SCREENING HIGH RELIABILITY STANDARD, /ES AND /SX

TEST PERFORMED	NON-QML <sup>1</sup>		
	STANDARD	/ES	/SX <sup>2</sup>
<b>Pre-cap Inspection, Method 2017, 2032</b>	■	■	■
<b>Temperature Cycle (10 times)</b>			
Method 1010, Cond. C, -65 °C to +150 °C, ambient			■
Method 1010, Cond. B, -55 °C to +125 °C, ambient		■	
<b>Constant Acceleration</b>			
Method 2001, 3000 g			■
Method 2001, 500 g		■	
<b>PIND, Test Method 2020, Cond. A</b>			■ <sup>3</sup>
<b>Burn-in Method 1015, +125 °C case, typical <sup>4</sup></b>			
96 hours		■	
160 hours			■
<b>Final Electrical Test, MIL-PRF-38534, Group A,</b>			
Subgroups 1 through 6, -55 °C, +25 °C, +125 °C case			■
Subgroups 1 and 4, +25 °C case	■	■	
<b>Hermeticity Test, Method 1014</b>			
Gross Leak, Cond. C <sub>1</sub> , fluorocarbon		■	■
Fine Leak, Cond. A <sub>2</sub> , helium		■	■
Gross Leak, Dip	■		
<b>Final visual inspection, Method 2009</b>	■	■	■

Test methods are referenced to MIL-STD-883 as determined by MIL-PRF-38534.

**Notes**

1. Non-QML products may not meet all of the requirements of MIL-PRF-38534.
2. All processes are QML qualified and performed by certified operators.
3. Not required by DLA but performed to assure product quality.
4. Burn-in temperature designed to bring the case temperature to +125 °C minimum. Burn-in is a powered test.

TABLE 11: ENVIRONMENTAL SCREENING HIGH RELIABILITY STANDARD, /ES AND /SX

