

FH-30001/30002/30003/30004 0°/180° HYBRIDS

TECHNICAL FEATURE

FEATURES

- 2 to 200 MHz

PERFORMANCE

Frequency Range.....	2 - 200 MHz
Isolation.....	30 dB min
Insertion Loss	0.75 dB max
VSWR.....	1.3:1 max
Phase Balance	$\pm 2^\circ$ max
Amplitude Balance	± 0.2 dB max
Impedance.....	50 Ohms
Power Handling	3 Watts max
Operating Temperature Range.....	-54 to +85° C

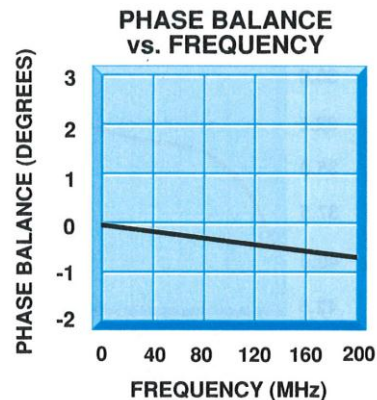
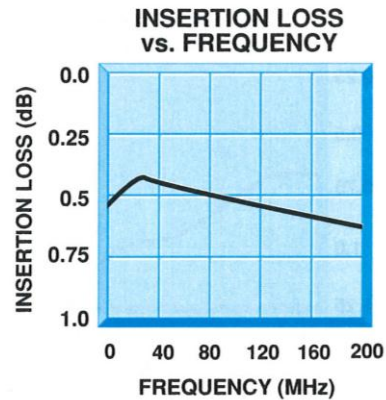
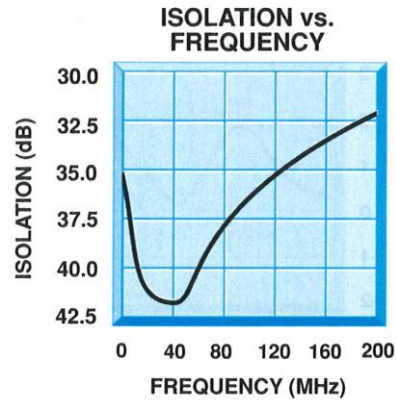

FUNCTIONAL SCHEMATIC

FH-30001

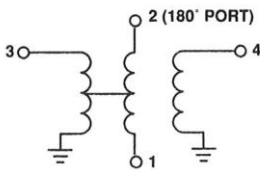

FH-30002, FH-30003

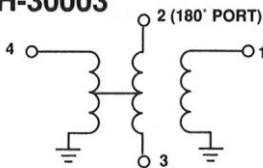

FH-30004

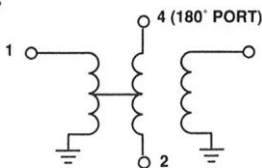

FH-30001/30002/30003/30004 0°/180° HYBRIDS

MECHANICAL OUTLINE

FH-30001

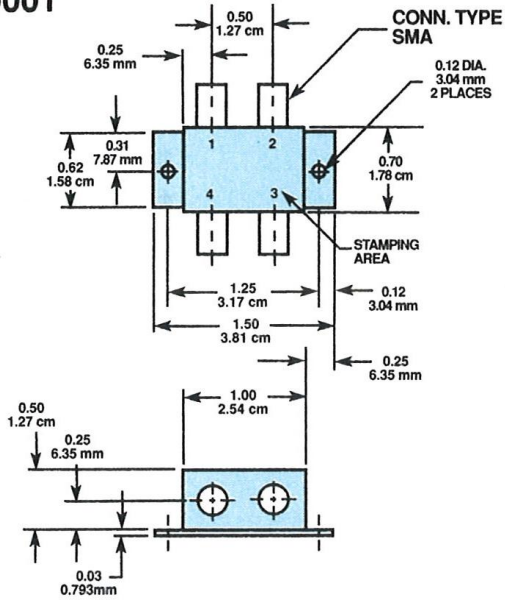

FH-30002

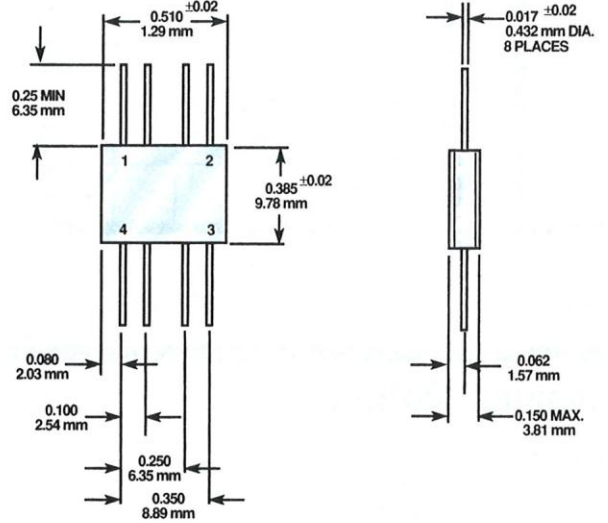

FH-30003

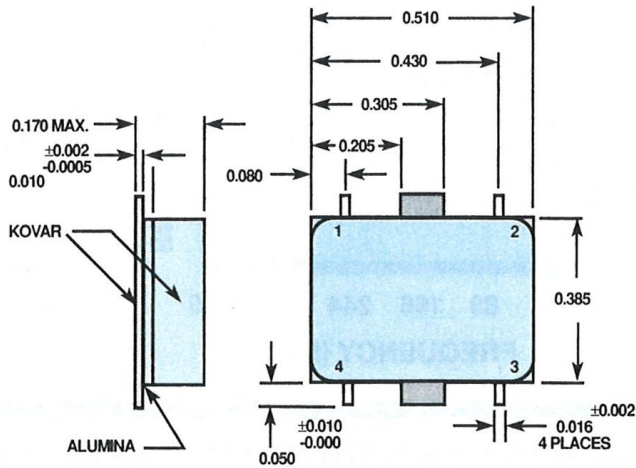

FH-30004

