

# HJ-22009 2-WAY 0° POWER DIVIDERS

## TECHNICAL FEATURE

### FEATURES

- 2 to 100 MHz

### PERFORMANCE

Frequency Range.....	2 – 100 MHz
Isolation.....	35 dB min
Insertion Loss .....	0.5 dB max
VSWR.....	1.3:1 max
Phase Balance .....	±1° max
Amplitude Balance .....	±0.1 dB max
Impedance.....	50 Ohms
Power Handling .....	3 Watts max
Operating Temperature Range.....	-54 to +85° C

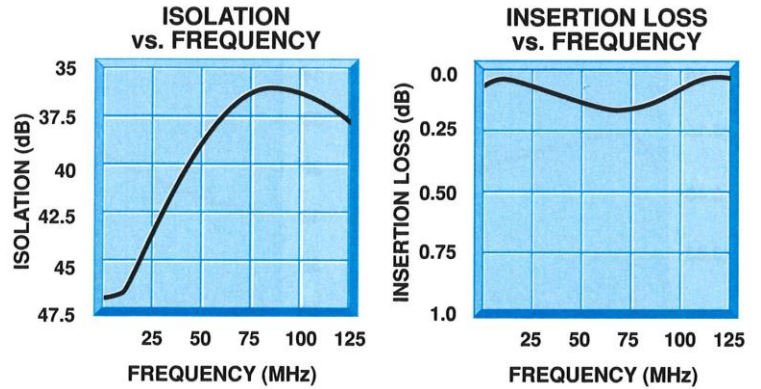

### MECHANICAL OUTLINE

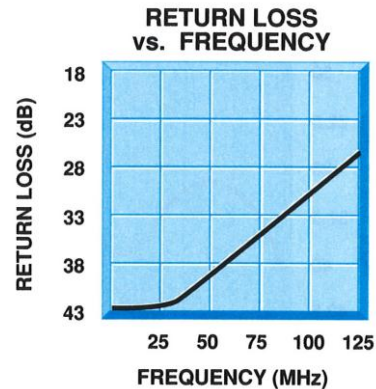
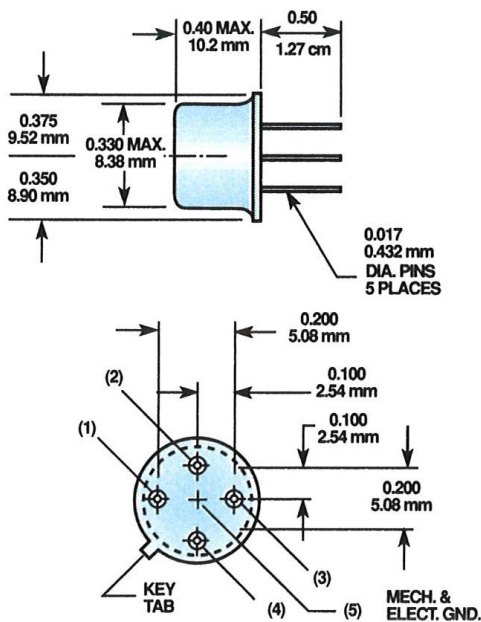

### FUNCTIONAL SCHEMATIC

