

HJ-52001/52002/52003 2-WAY 0° POWER DIVIDER

TECHNICAL FEATURE

FEATURES

- 20 to 1000 MHz

PERFORMANCE

Frequency Range.....	20 - 1000 MHz
Isolation.....	20 dB min
Insertion Loss	1.0 dB max
VSWR.....	1.4:1 max
Phase Balance	$\pm 4^\circ$ max
Amplitude Balance	± 0.2 dB max
Impedance.....	50 Ohms
Power Handling.....	3 Watts max
Operating Temperature Range.....	-54 to +85° C

FUNCTIONAL SCHEMATIC

HJ-52001

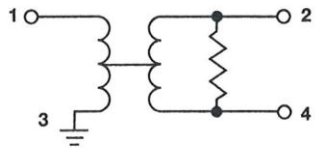

HJ-52002

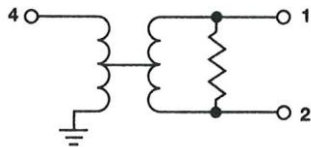

HJ-52003

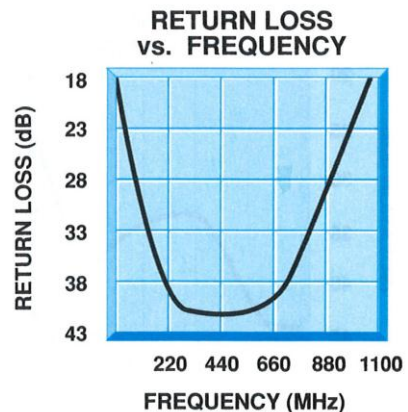
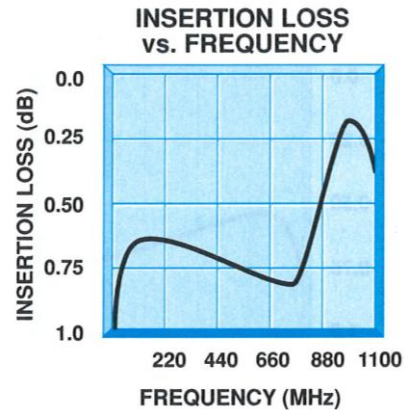
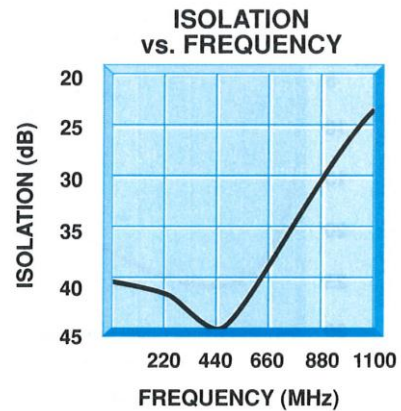
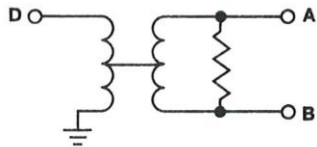

HJ-52001/52002/52003 2-WAY 0° POWER DIVIDER

MECHANICAL OUTLINE

HJ-52001

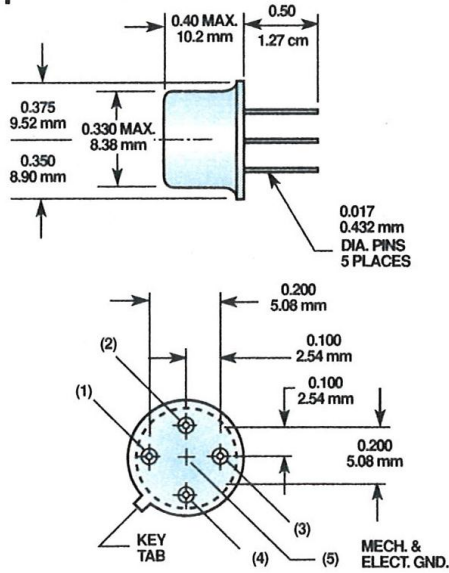

HJ-52002

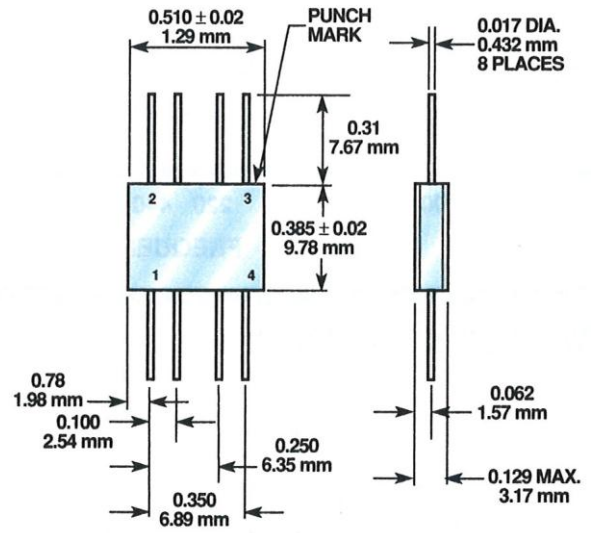

HJ-52003

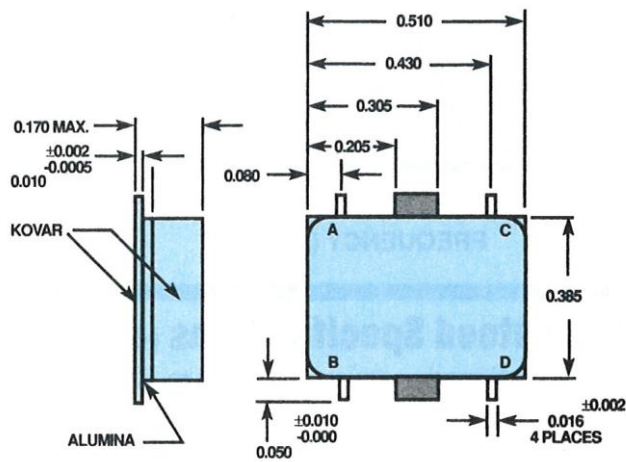

HJ-52001/52002/52003 2-WAY 0° POWER DIVIDER